

# **Dehydration of Biomass-derived Carbohydrates in a Biphasic Reactor using Cation Exchange Resin Catalyst for the Production of Hydroxymethylfurfural and Furfural**

*A thesis Submitted to Indian Institute of Technology Hyderabad In Partial Fulfillment of the Requirements for The Degree of Master of Technology*

By

**K. Alekhya**

*Under the guidance of*

Dr. Sunil K. Maity



भारतीय प्रौद्योगिकी संस्थान हैदराबाद  
Indian Institute of Technology Hyderabad

**Department of Chemical Engineering  
Indian Institute of Technology Hyderabad**

**June, 2016**

## Declaration

I declare that this written submission represents my ideas in my own words, and where others' ideas or words have been included, I have adequately cited and referenced the original sources. I also declare that I have adhered to all principles of academic honesty and integrity and have not misrepresented or fabricated or falsified any idea/data/fact/source in my submission. I understand that any violation of the above will be a cause for disciplinary action by the Institute and can also evoke penal action from the sources that have thus not been properly cited, or from whom proper permission has not been taken when needed.



---

K. Alekhya

CH14MTECH11006

## APPROVAL SHEET

This Thesis entitled "*Dehydration of Biomass-derived Carbohydrates in a Biphasic Reactor using Cation Exchange Resin Catalyst for the Production of Hydroxymethylfurfural and Furfural*" by K. Alekhya is approved for the degree of Master of Technology from IIT Hyderabad.



Dr. Devarai Santhosh Kumar  
Assistant Professor  
Dept. of Chemical Engineering  
Indian Institute of Technology Hyderabad  
Examiner

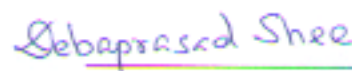

Dr. Debaprasad Shee  
Assistant Professor  
Dept. of Chemical Engineering  
Indian Institute of Technology Hyderabad  
Examiner



Dr. Sunil Kumar Maity  
Associate Professor  
Dept. of Chemical Engineering  
Indian Institute of Technology Hyderabad  
Adviser



Dr. Jyotsnendu Giri  
Assistant Professor  
Dept. of Biomedical Engineering  
Indian Institute of Technology Hyderabad  
Chairman

## **Acknowledgement**

First and foremost, I want to thank my adviser Dr. Sunil Kumar Maity, Associate professor, Indian Institute of Technology, Hyderabad for the continuous support throughout my course work and providing excellence guidance throughout this research. His patience, motivation and enthusiasm have deeply inspired me and helped me in all the phases of research. I am extremely grateful for what he has offered me. I am also thankful to the supervisory committee members Dr. Debaprasad Shee, Dr. Santosh Kumar Devarai and Dr. Jyotsnendu Giri for giving me valuable suggestions.

I would like to thank my lab mates for their encouragement and support, especially Y. Sudhakar Reddy, PhD and M. Swarnalatha, PhD. Lastly, I would like to thank my family for their love and support.

Alekhya

## **Abstract**

Biomass is a source of carbohydrates, which is composed of two different types of sugars hexose (glucose, galactose and mannose) and pentose (xylose and arabinose). These sugars can be dehydrated to produce platform chemicals like 5-HMF (5-hydroxymethylfurfural) and furfural. These are most promising chemicals because they are used in the production of fine chemicals, polymers and also starting materials for new products as well as for replacement of oil-derived chemicals. This work focuses on the production of 5-HMF and Furfural by dehydration of fructose and xylose respectively. Dehydration of carbohydrates in aqueous phase can produce unwanted products because of side reactions such as rehydration, hydrolysis and condensation. To eliminate unwanted side reactions an organic phase and inorganic salt were added to the system. Organic phase consisting of solvents which can extract the product from aqueous phase as it formed to eliminate the degradation of product and addition of salt to the reaction system will increase the partition coefficient. Dehydration reaction was performed in a batch reactor over a cation exchange resin catalyst. Effect of reaction parameters such as temperature, time, and feed compositions were optimized to increase the yield. Effect of salt was studied and concluded that product concentration depends on salt concentration because of salting-out effect. Difference between using glucose and fructose to produce 5-HMF was also studied and concluded that using fructose product concentration increased compared to the glucose. The reason behind this is dehydration of glucose can produce ene-diol intermediate which consists of unstable ring structure that can produce unwanted by products. So, glucose was initially isomerized to fructose and then dehydrated to produce 5-HMF. After the dehydration reaction, organic phase was separated from aqueous phase and analyzed using GC-MS (gas chromatography mass spectroscopy) to identify the product and using GC (gas chromatography) to quantify the product. From the results we can conclude that product concentration was increased with increasing fructose and salt concentrations.

## Nomenclature

5-HMF	5-Hydroxymethylfurfural
FDCA	Furan dicarboxylic acid
THF	Tetrahydrofuran
MeTHF	Methyl tetrahydrofuran
THFA	Tetrahydro furoic acid
DMF	Dimethylformamide
DMA	Dimethylacetamide
MIBK	Methyl isobutyl ketone
DMSO	Dimethyl sulfoxide

## List of tables

Table. 1. Properties of 5-HMF.....	17
Table 2. Literature review on production of 5-HMF .....	18
Table 3. Properties of furfural.....	23
Table 4. Literature review on production of furfural.....	24
Table 5. Effects of salt concentration. ....	33
Table 7. Effects of temperature for dehydration of fructose.....	36
Table 8. Effects of temperature for dehydration of fructose.....	37

## List of figures

Fig. 1. Platform chemicals. ....	10
Fig. 2. Derivatives of 5-HMF. ....	12
Fig. 3. Derivatives of furfural. ....	13
Fig. 4. Biphasic reactor .....	14
Fig. 5. Structure of 5-HMF. ....	17
Fig. 6. Mechanism of dehydration of glucose.....	22
Fig. 7. Structure of furfural. ....	23
Fig. 8. Mechanism of dehydration of xylose. ....	27
Fig. 9. Experimental setup (batch reactor).....	28
Fig. 10. Chromatogram of dehydration of fructose over cation exchange resin catalyst. ....	30
Fig. 11. Chromatogram of dehydration of glucose over cation exchange resin catalyst. ....	31
Fig. 12. Chromatogram of dehydration of xylose over cation exchange resin catalyst. ....	32
Fig. 13. Effect of salt concentration.....	33
Fig. 14. Effects of fructose concentration.....	35
Fig. 15. Effects of temperature for dehydration of fructose. ....	37
Fig. 16. Effects of temperature for dehydration of fructose. ....	38



# Contents

Abstract .....	4
Nomenclature .....	5
List of tables.....	6
List of figures .....	7
1. Introduction.....	9
1.1. Derivatives potential of 5-HMF and furfural .....	11
2. Literature review .....	14
2.1. Reaction system.....	14
2.2. Catalysts .....	15
2.3. Solvent and salt .....	15
2.4. 5-HMF .....	17
2.4.1. Properties of 5-HMF.....	17
2.4.2. Synthesis of 5-HMF.....	17
2.5. Furfural.....	23
2.5.1. Properties of furfural .....	23
2.5.2. Synthesis of furfural .....	23
3. Objectives .....	27
4. Experimental .....	27
4.1. Materials.....	27
4.2. Experimental setup and procedure .....	28
4.3. Product analysis.....	29
5. Results and discussion .....	29
5.1. Identification of product.....	29
5.2. Effects of salt concentration.....	32
5.4. Effects of temperature .....	35
6. Conclusions.....	38
7. Future work.....	39

## 1. Introduction

In recent years, usage of non-renewable resources to produce energy, polymers and organic chemicals increasing. According to International Energy Agency (2011) more than 80% of energy and 90% of organic chemicals in the world are derived from fossil fuels alone. Mainly the energy consumption was growing due to rapid increase in world's population. There are so many disadvantages using non-renewable energy resources which causes global warming, air pollution due to the emission of harmful and greenhouse gases. Renewable biomass has become an attractive alternative resource to fossil fuels because of its abundant availability in nature, reduced emissions of carbon in the atmosphere, world-wide distribution and is the only renewable resource which can be converted to organic chemicals. Biomass can be transformed to value-added chemicals using refinery methods and advanced technologies. These chemicals include the same products which were produced from petroleum. The production of organic chemicals from renewable biomass is a promising route to decrease our dependence on petroleum and to mitigate environmental issues.

Biomass is a source of carbohydrates which can be converted to monosaccharide sugars such as hexose and pentose. These monosaccharide sugars further processed by biological or catalytic processes to platform chemicals as shown in the [Fig. 1](#). These platform chemicals are the starting materials in the formulation of everyday products.

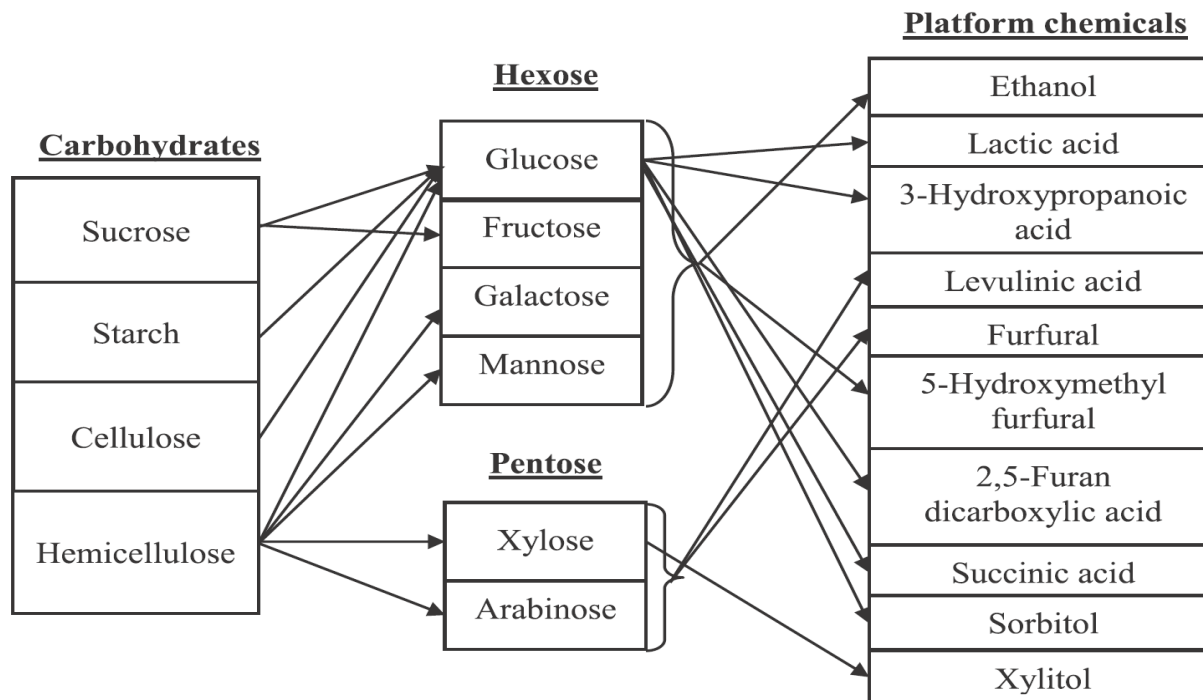

**Fig. 1.** Platform chemicals.

Among these platform chemicals most promising chemicals are 5-hydroxymethylfurfural (5-HMF) and furfural (furans) because they are used in the production of fine chemicals, polymers, pharmaceuticals and also starting materials for new products. The main advantage is these compounds can be used for the replacement of oil-derived chemicals. 5-HMF and furfural are first reported at the end of nineteenth century using sugar cane as feed stock. After that, other preparation methods were conducted in aqueous media using homogeneous and heterogeneous acid catalysis. Some of these are comprehensive while others just mentioned the chemistry of the reaction [1]. According to these reviews HMF and furfural can be synthesized by catalytic dehydration of carbohydrates. The process starts with hydrolysis of polysaccharides to monosaccharides, which are subsequently dehydrated to form carbonyl containing furan compounds such as 5-HMF and furfural. By oxidation, hydrogenation, hydrogenolysis these chemicals can be further transformed into useful chemicals which can be used as monomers in the synthesis of new polymeric materials. Main challenge during the reaction is the possibility of unwanted side reactions. These side reactions produce different by-products, which can be eliminated using a proper solvent, salt and required process conditions. Although a lot of

improvements have been made to eliminate the side reactions, still it has always been a challenge to understand the reaction mechanism and increasing the selectivity of 5-HMF and furfural.

The present work briefly explains the derivatives of 5-HMF and furfural, and also the literature review available for the production of these compounds. This work mainly describes the production of 5-HMF and furfural from catalytic dehydration of carbohydrates, effect of reaction parameters such as temperature, solvent, salt and composition of feed, different catalytic systems available and the reaction mechanism.

### **1.1. Derivatives potential of 5-HMF and furfural**

HMF is used in food industries as an index of deteriorative changes that take place during excessive heating or prolonged storage of foods. It can also be used in pharmaceuticals such as in therapy of sickle disease [2]. 5-HMF is known as ‘sleeping giant’ in the field of intermediate chemicals. The presence of furan ring and two functional groups were the main reason for various chemical transformations of 5-HMF and the synthesis of alternative fuels. Derivatives such as dimethylfuran, 5-hydroxymethyl furoic acid, adipic acid, 2,5-furandicarboxylic acid etc are produced from the 5-HMF which are shown in Fig. 2. [3,1]. Other than this, 5-HMF can also be used in fuelcells.

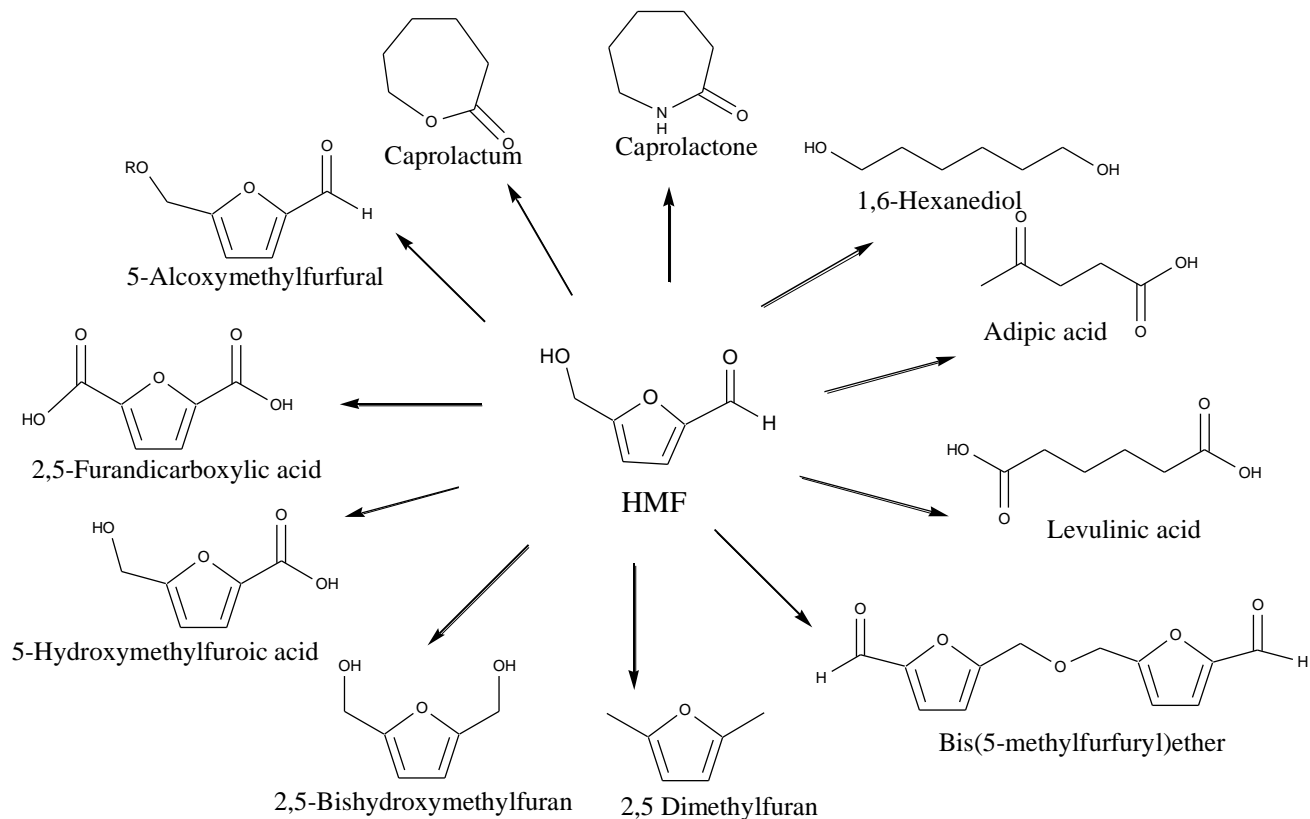
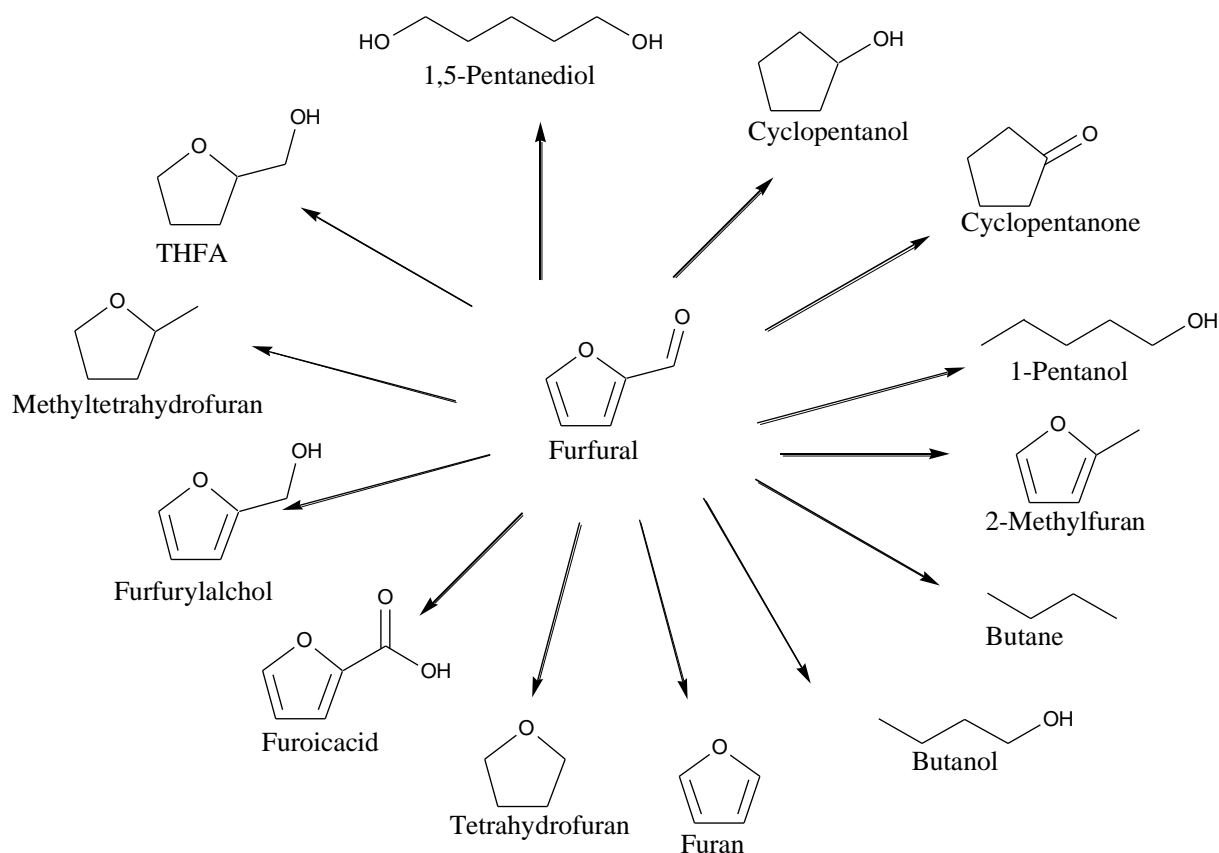

**Fig. 2.** Derivatives of 5-HMF. [3]

Alcoxymethylfurfural, 2,5-Dimethylfuran are used in biofuels and 5-Hydroxymethylfuroicacid, FDCA, FDC are used in preparation of pharmaceuticals, polymers, resins. FDC was utilised in the synthesis of various macrocyclic compounds. Formic acid and adipic acid are main derivatives which can also be used as catalyst and solvent. Adipic acid is used as precursor for the production of nylon, and also used in the chemical industry to produce other polymers, coatings, plasticizers and detergents. Caprolactam is an intermediate used in the production of fibres and resins. Levulinic acid and its derivatives are important in production of fuels and fuel additives.

Furfural is mainly used as an extractant, wetting agent, fungicide, nematocide, solvent for the refining of lubricating oils and diesel fuels, and as an intermediate chemical in the manufacturing of solvents such as tetrahydrofuran (THF), methyl tetrahydrofuran (MeTHF), furfuryl alcohol and plastics. Many derivatives such as furfuryl alcohol, furan resins, Levulinic acid, furoic acid, 2-methyl furan, furan, 2-acetyl furan, 2,5-dimethoxydihydrofuran, and furfuryl amine are

synthesized from furfural which are shown in Fig. 3. [4]. Furfural and its derivatives are also used as gasoline blend stock, and to develop the next generation of biofuels and bioplastics.



**Fig. 3.** Derivatives of furfural. [5]

Furfuryl alcohol is the main derivative of furfural which can be used in the manufacture of foundry resins. These resulted resins possess excellent chemical, thermal and mechanical properties, in addition to withstanding corrosion and solvent action. Furfuryl alcohol has also been used in the manufacture of furan fiber-reinforced plastics in piping industries, and it is also recommended for high performance chemical processes where chlorinated aromatics, oxygenated organic solvents are used. THFA and THF are known as green solvents because of their use as solvents in agricultural applications, printing inks and industrial applications. Other derivatives butanol, 2,5-pentanediol are important chemicals to produce pharmaceuticals, insecticides and rubber chemicals.

## 2. Literature review

In this review, the overview of different types of catalysts and solvents that are used to produce 5-HMF and furfural from carbohydrates are provided. Furanic compounds are mainly produced from the dehydration of monosaccharides such as hexose and pentose respectively.

### 2.1. Reaction system

Three types of different systems are employed for the synthesis: aqueous, biphasic and ionic liquid systems. Ionic liquid system has drawbacks such as higher viscosity, poor transport properties, high corrosivity which leads to equipment damage and cost of the ionic liquids hundred times larger than the organic solvents [6]. Compared with aqueous system, it is easier to separate product and to recycle the catalyst using a biphasic system. Here the batch reactor is used as a biphasic reactor which contains an aqueous phase of water, carbohydrates, catalyst, salt and an organic phase of a solvent. Biphasic reactor is shown in the Fig. 4.

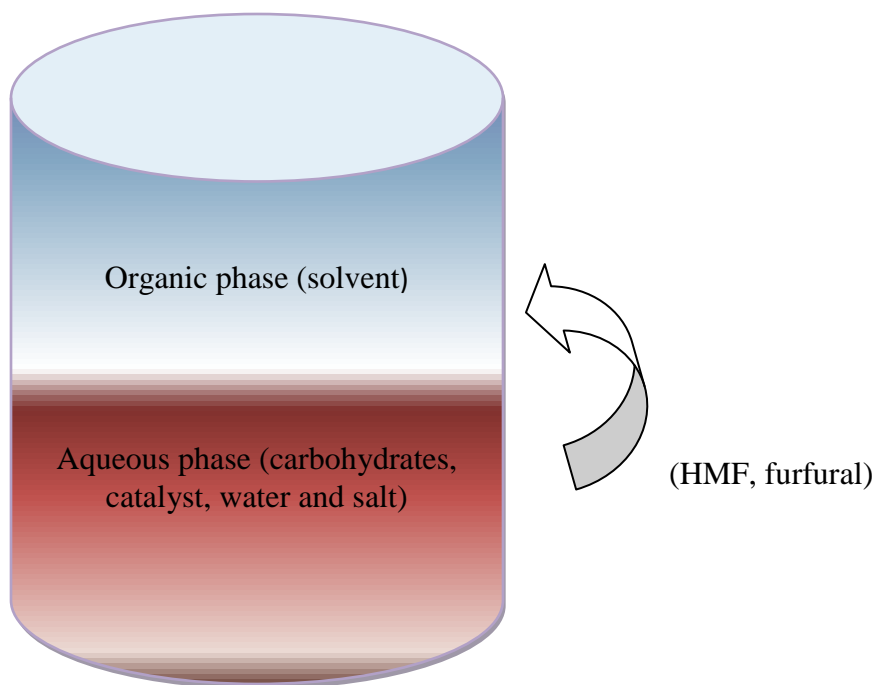

**Fig. 4.** Biphasic reactor

## 2.2. Catalysts

Generally, there are three types of catalysts homogeneous, heterogeneous and enzyme catalysts. Enzyme catalysts are more expensive and requires purification of feed when compared to other catalysts. It is easier to recycle catalyst and to separate product from heterogeneous catalysts than homogeneous catalysts. In heterogeneous, solid acid catalysts have several advantages over other catalysts such as

- 1) They can be easily separated from product and can be recycled.
- 2) They can work at high temperatures by decreasing the reaction time which can favors the formation of required product instead of its decomposition during a prolonged reaction period,
- 3) They are capable of adjusting the surface acidity to improve the selectivity of HMF and furfural, which will be very useful in the conversion of biomass feed stocks.
- 4) In addition, heterogeneous acid catalysts can offer high selectivity towards HMF and have the potential for industrial process.

Solid acid catalysts generally includes zeolites, heteropolyacid catalysts, ion-exchange resins, mesoporous and  $\text{SiO}_2\text{-Al}_2\text{O}_3$  catalysts. As explained in literature[7] using zeolites carbohydrates produced low yield and selectivity. Ion-exchange resins decreases the formation of by-products because they reduce rehydration of products formed. More work have to done in this area using different types of solid acid catalysts to increase the yield and the properties of catalysts should be studied during the experiment.

## 2.3. Solvent and salt

The dehydration of carbohydrates into 5-HMF and furfural is generally catalyzed by a solid acid catalyst, but side products are sometimes formed due to subsequent hydrolysis, rehydration and degradation of products. Dehydration of fructose in pure water is generally non-selective because of formation of by-products due to further rehydration of 5-HMF and furfural. The degradation of products in aqueous phase can be reduced by extracting them from the aqueous reaction mixture as it is being formed. For this purpose, an organic phase, which is immiscible with the aqueous phase can be used. Biphasic systems, in which a water immiscible organic solvent is added to extract continuously the required products from the aqueous phase, offer an important advantage in that the product is separated from the reactant and reaction



intermediates and is thereby protected against degradation reactions. A number of solvents are widely used for synthesis, such as dimethylformamide(DMF), toluene, dimethylacetamide(DMA), tetrahydrofuran(THF), methylisobutyl ketone (MIBK), butanol and ethyl acetate etc as shown in Table 2 and 4. Selection of the solvent depends on improvement in selectivity, energy and material costs, ease of separation and recycling, operational safety and chemical toxicity. Extraction of the product is also depends on the polarity of the solvent, if the solvent is highly polar then it will be easy to separate the product from aqueous phase. Among these, MIBK and butanol can increase the selectivity from 60% to 83% when compared to other solvents [8] because 5-HMF is highly soluble in these solvents. When compared to other solvents boiling point of these solvents is less than 120 °C, hence low energy is required to separate them from product by evaporation. DMSO is one of the most important aqueous solvent which can decrease the unwanted side reactions. A major reason for this is that DMSO would suppress both the formation of condensation and the rehydration of product by lowering the overall water concentration at high enough temperatures (>150 °C). After addition of DMSO, they will arrange themselves around the hydrogen atoms of the hydroxyl groups of carbohydrates which leads the directly contacting the oxygen atoms of the hydroxyl groups and water molecules. This prevents the carbohydrate from forming reversion and polymerisation products and allows the water molecules to transfer protons to the hydroxyl oxygen, thereby initiating the dehydration to 5-HMF [9]. The addition of DMSO to the reaction medium and the use of an organic phase, to extract product from the aqueous reaction medium, increase the selectivity from less than 50% to more than 90%. However, large scale production from sugars is currently facing economic challenges, because high energy is required to separate 5-HMF and furfural from a high boiling aprotic solvent like DMSO.

The partition coefficient (defined as the ratio of the product concentrations in the organic and aqueous phases) increases by adding inorganic salt to the system compared to non-salt systems. Salting-out effect of a salt is the main reason behind increasing the partition coefficient. When salt is added to the reaction system, it will attract the water molecules so that the product and water interaction will be reduced [10]. The presence of an inorganic salt increases the upper critical solution temperature, thereby allowing partially miscible solvent mixtures to remain biphasic even at higher temperatures and also prevents dehydration and degradation of product in the biphasic system [11]. Compared to other salts NaCl has highest partition coefficient and it is

less expensive. The magnitude of the hydrated ionic radius is an important factor in the salting-out effect, with smaller hydrated ions, such as  $\text{Na}^+$  and  $\text{K}^+$ , having a stronger influence on the salting-out effect than larger hydrated ions, such as  $\text{Li}^+$ .

## 2.4. 5-HMF

### 2.4.1. Properties of 5-HMF

5-HMF is a yellow solid with melting point of 303-307K, boiling point of 387-389K and density of 1.206 g/ml. It is soluble in a range of solvents, such as water, methanol, butanol, ethanol, benzene, acetone, chloroform, ethyl acetate, MIBK and formaldehyde. The presence of two functional groups in 5-HMF, combined with the furan ring, makes it an appealing starting material for various chemical transformations. Its physical properties are listed in [Table 1](#).

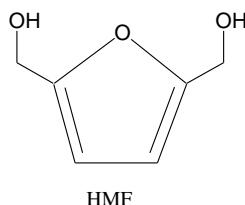

**Fig. 5.** Structure of 5-HMF.

<b>Table 1.</b> Properties of 5-HMF.	
Formula	$\text{C}_6\text{H}_6\text{O}_3$
Molecular weight	126.11 g/mol
Density	1.243 g/mL at 25°C
Melting point	114-116°C
Boiling point	28-34 °C
Solubility	Freely soluble in water, methanol, acetone, benzene.

### 2.4.2. Synthesis of 5-HMF

5-HMF is synthesized mainly by the dehydration of glucose and fructose. In general, glucose is much cheaper and abundant material in the universe but the reactivity of glucose is lower than the fructose because of its stable ring structure. This structure of glucose leads to acyclic enediol intermediate which decreases the selectivity of 5-HMF. To eliminate this ene-diol intermediate, isomerization of glucose to fructose is necessary to obtain 5-HMF from glucose [12]. The conversion of glucose into 5-HMF could proceed in two steps: the first isomerization of glucose to fructose in the presence of enzyme, followed by the dehydration of fructose to 5-HMF. A brief

review on dehydration of carbohydrates is presented in the below [Table 2](#). Different types of feed stocks, reactor systems, catalysts, solvents used and process conditions are included in the [Table 2](#).

<b>Table 2.</b> Literature review on production of 5-HMF					
<b>Feedstock</b>	<b>Catalyst</b>	<b>Solvent</b>	<b>Reactor</b>	<b>Process conditions</b>	<b>Ref</b>
Glucose	Sn-Beta Zeolite, HCl	Tetrahydrofuran	Biphasic Reactor	433K, 90 min	[13]
Fructose	HCl	Butanol	Biphasic Reactor	453K, 7.35 bar	[14]
Glucose – Fructose mixture	HCl	Acetone	Aqueous phase Reactor	453K, 50 bar, 120 min	[15]
Fructose	NA-P, Niobic acid treated with H3PO4	2-Butanol	Biphasic Reactor	433K, 20MPa, 110 min	[16]
Fructose	Solid Heteropoly Acid Catalyst	MIBK	Biphasic Reactor	388K, 60 min	[17]
Glucose	CSZA(Bifunctional Catalyst)	DMSO	Biphasic Reactor	423K, 360 min	[18]
Glucose	AlCl <sub>3</sub> (Lewis acid metal chloride), HCl	2-sec-butylphenol	Biphasic Reactor	443K, 40 min	[19]
Glucose	Al doped MCM silica catalyst	MIBK	Biphasic Reactor	463K, 150min	[20]
Fructose	Titanium hydrogenphosphate	THF	Biphasic Reactor	413K, 3h	[21]
Glucose	AlCl <sub>3</sub> .6H <sub>2</sub> O	THF	Aqueous phase Biphasic	433K, 10 min 453K, 30 min	[22]
Glucose	AlCl <sub>3</sub>	N,N-dimethylacetamide	Biphasic Reactor	403K, 15 min	[23]
Glucose	InCl <sub>3</sub>	THF	Biphasic Reactor	473K, 2h	[24]
Glucose	Niobium phosphate	MIBK	Biphasic reactor	408K,	[25]
Glucose	SnCl <sub>4</sub> -TBAB	Dimethyl acetamide	Biphasic reactor	373K, 2h	[26]

Fructose	Sulfated zirconia	DMSO	Biphasic reactor	473K, 2MPa, 20min	[27]
Fructose	(SO <sub>4</sub> <sup>2-</sup> /SnO <sub>2</sub> -ZrO <sub>2</sub> )	THF	Biphasic reactor	393K, 2.5h	[28]
Glucose	Al <sub>2</sub> O <sub>3</sub> -B <sub>2</sub> O <sub>3</sub>	DMSO	Aqueous phase reactor	413K, 120min	[29]
Glucose	[Sn,Al] Beta catalysts	DMSO	Aqueous phase reactor	433K, 30min-5h	[30]
Fructose	HCl or H <sub>2</sub> SO <sub>4</sub>	1-Butanol	Biphasic reactor	423K,	[11]
Glucose	CrCl <sub>2</sub> or CrCl <sub>3</sub>	DMSO	Biphasic reactor	393K, 1h	[31]
Fructose	Amberlyst, niobic acid, H <sub>2</sub> SO <sub>4</sub>	DMSO	Biphasic reactor	353-373K, 3h	[32]
Sucrose	CrCl <sub>3</sub> -NH <sub>4</sub> Br	N,N-dimethylacetamide	Biphasic reactor	373K, 1h	[33]
Fructose or Glucose	Alkaline earth phosphates	Acetone	Batch reactor(mono)	473-493K	[34]
Glucose	SO <sub>4</sub> -ZrO <sub>2</sub>	Water	Aqueous phase reactor	473-673K, 2.5 MPa	[35]
Glucose	CrCl <sub>3</sub> .6H <sub>2</sub> O	DMSO	Biphasic reactor	383-403K, 3h	[36]
Fructose	Electrogenerated acid	DMSO	Biphasic reactor	Room temperature	[37]
Glucose	Nano PMO/ZrO <sub>2</sub> /γ-Al <sub>2</sub> O <sub>3</sub>	Dimethyl ether	Biphasic reactor	463K, 4h	[38]
Fructose	Dealuminated H-form mordenites	MIBK	Biphasic reactor	438K, 1h	[39]
Glucose	γ-zeolite	Deionized water	Aqueous phase reactor	383-433K	[40]
Fructose	NH <sub>4</sub> Cl	Ethanol	Aqueous phase reactor	373K	[41]
Fructose	Zirconium-Titanium-Hydrogenphosphate	MIBK	Biphasic reactor	383K, 0.5h	[42]
Fructose	TEAC	THF Co-catalyst NaHSO <sub>4</sub> .H <sub>2</sub> O	Biphasic reactor	393K, 70min	[43]

Fructose	Zeolite (Si/Al)	Water or zeolite solution	Aqueous phase reactor	403K, 1.25-3.25h	[44]
Glucose	Dealuminated Beta Zeolite	THF	Biphasic reactor	443K, 3h	[45]
Fructose	Fe <sub>2</sub> O <sub>3</sub>	DMSO	Biphasic reactor	393K, 240min	[46]
Fructose	ZrOCl <sub>2</sub>	MIBK	Biphasic reactor	393K, 30min	[47]
Glucose	Pt and Ru supported on activated carbon	Ethanol	Aqueous phase reactor	453K, 1.6mPa	[48]
Glucose	Tantalum phosphate	MIBK	Biphasic reactor	443K, 1h	[49]
Glucose	AlCl <sub>3</sub>	Ethanol	Aqueous phase reactor	433K	[50]
Fructose	Amberlyst-15	Dimethylformamide	Biphasic reactor	393K, 30min	[51]
Fructose	Amberlyst-70	DMSO	Biphasic reactor	413K, 1h	[52]
Glucose	Amberlyst-Hydrotalcite	N,N-Dimethyl formamide	Biphasic reactor	373K, 2.5-3h	[53]
Fructose	N,N- dimethyl ura	CrCl <sub>2</sub>	Biphasic reactor	383K, 2h	[54]
Fructose	Glucose-toluenesuphonic acid	DMSO	Biphasic reactor	403K, 1.5h	[55]
Glucose	Sn-Mont	THF-DMSO	Biphasic reactor	433K, 3h	[56]
Fructose	Cation-exchange resin	Acetone/DMSO	Biphasic reactor	423K, 10mPa 20min	[57]
Fructose	Acid catalyst (H <sub>2</sub> SO <sub>4</sub> )	DMSO	Biphasic reactor	423K,	[58]
Glucose	TiO <sub>2</sub>	MIBK	Biphasic reactor	453K, 60min	[59]
Fructose	Amberlyst-70	2,5-dihydroxymethyl tetrahydrofuran	Aqueous phase reactor	403K	[60]
Fructose	SBA-15 silica	MIBK:2-Butanol (2:3)	Biphasic reactor	453K	[61]

Glucose	SO <sub>4</sub> <sup>2-</sup> /SnO <sub>2</sub>	Water	Aqueous phase system	448K, 4h	[62]
Fructose	Niobic acid	Water	Aqueous phase system	373K, 2-6bar	[63]
Fructose	-	MIBK	Biphasic reactor	433K, 2h	[64]
Glucose	Lewis acid metal salts (MCl <sub>3</sub> )	Sec-butylphenol	Biphasic reactor	443K,	[65]
Fructose	-	DMSO	Biphasic reactor	423K, 10min	[66]
Fructose	Formic acid	Butanol	Biphasic reactor	443K, 70min	[67]
Glucose	ZnCl <sub>2</sub>	Water	Aqueous phase reactor	393K, 12h	[68]
Glucose	AlI <sub>3</sub>	N,N-dimethyl acetamide	Biphasic reactor	393K, 15min	[69]
Fructose	TiO <sub>2</sub> -ZrO <sub>2</sub>	Water	Aqueous phase reactor	473K	[70]
Fructose	FeCl <sub>3</sub> and tetra ethyl ammonium bromide	Water and NMP	Biphasic reactor	363K, 2h	[71]
Glucose	ScCl <sub>3</sub>	N,N-dimethyl acetamide	Biphasic reactor	418K	[72]
Glucose	AlCl <sub>3</sub>	THF	Biphasic reactor	393K, 30min	[72]
Fructose	Vanadyl phosphate	Water	Aqueous phase reactor	353K	[73]
Fructose	Zirconium phosphate	Water	Aqueous phase reactor	513K, 3.35MPa, 120s	[74]
Fructose	Zeolite (mordenite)	MIBK	Biphasic reactor	438K	[75]
Glucose	Mesoporous tantalum oxide	MIBK	Biphasic reactor	448K, 90min	[76]
Fructose	H-BEA-18	Water MIBK	Aqueous phase Biphasic	403K, 5h	[77]
Fructose	Boric acid	MIBK	Biphasic reactor	420K, 5h	[78]

Fructose	Amberlyst	DMF	Biphasic reactor	373K, 15h	[79]
----------	-----------	-----	------------------	-----------	------

There are different feed stocks, catalysts, and solvents used for the production of 5-HMF in the available literature. Zhang et al. studied the catalysts amberlyst, sulfuric acid and niobic acid in presence of DMSO [32]. It was concluded that in presence of DMSO and ion-exchange resin formation of by-products decreased and yield increased. Ordonsky et al. compared zeolites with different Si/Al ratio and said that amorphous aluminosilicate does not increase the selectivity [75]. Watanabe et al. told that resin maintained its activity at 150 °C, and its catalytic activity remained stable after the resin had been reused five times [57]. The mechanism of the isomerization of glucose and dehydration of fructose is shown in Fig. 6. In first step glucose is isomerized to fructose and then in second step fructose dehydrated to 5-HMF [19].

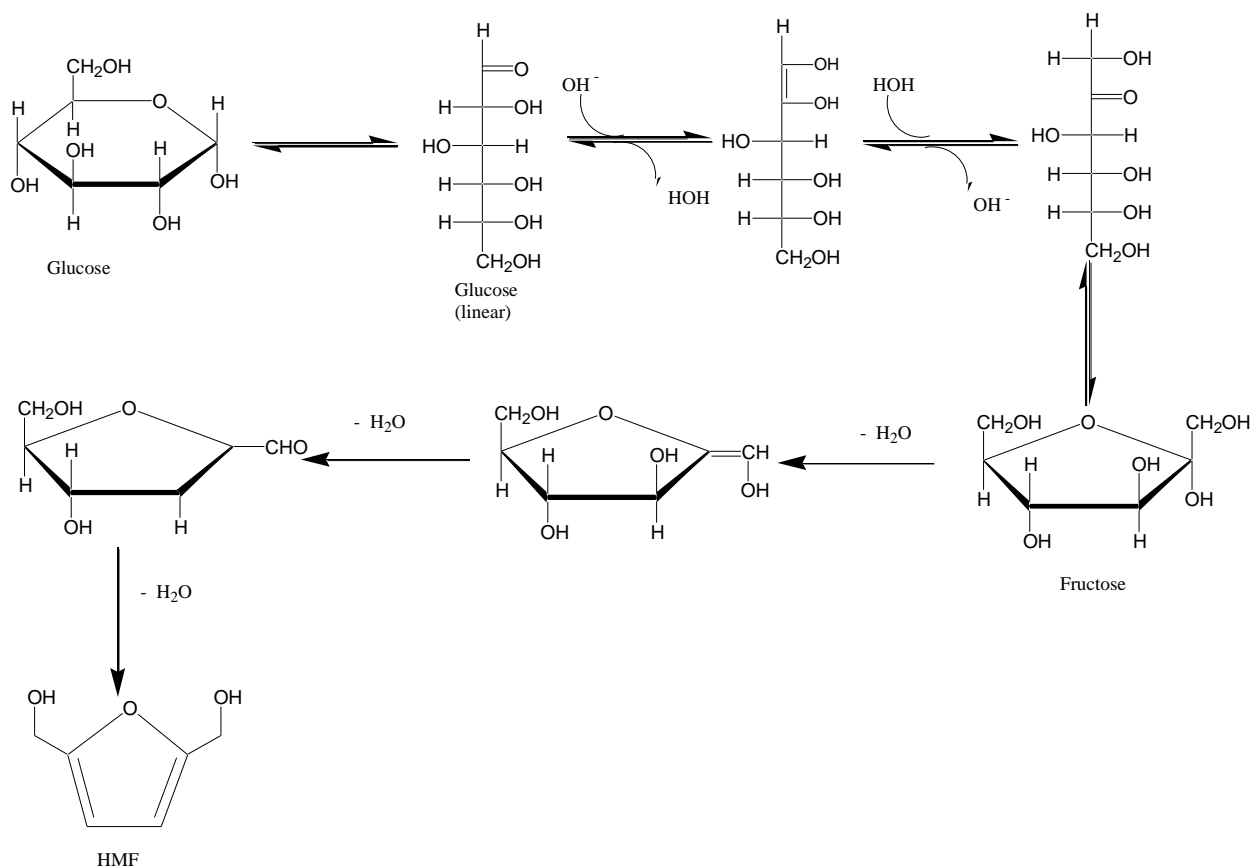
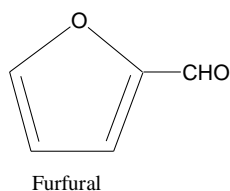

**Fig. 6.** Mechanism of dehydration of glucose.[19]

## 2.5. Furfural

### 2.5.1. Properties of furfural

Furfural is a versatile platform chemical consists of a heteroaromatic furan ring and an aldehyde functional group as shown in the Fig. 7. Furfural is a useful chemical intermediate mainly used as a solvent for chemical refining and resin synthesis in the petrochemical and automotive industries. In addition, researchers have recently shown that furfural can serve as precursor for production of liquid alkanes (C<sub>7</sub>–C<sub>15</sub>) that serve as diesel fuel components. Its properties are represented in Table 3.



**Fig. 7.** Structure of furfural.

<b>Table 3.</b> Properties of furfural.	
Formula	C <sub>5</sub> H <sub>4</sub> O <sub>2</sub>
Molecular weight	96.1 g/mol
Density	1.16 g/ml at 20°C
Melting point	-37°C
Boiling point	161.7°C
Solvent solubility	Miscible in octanol, xylene and methanol

### 2.5.2. Synthesis of furfural

The synthesis of Furfural involves two steps: primary step is the hydrolysis of pentosan (cellulose or hemicellulose) which gives respective pentose (monosaccharide), followed by the secondary step catalytic dehydration of pentose to furfural. Current review is mainly focused on the dehydration of pentose. The aqueous phase is favorable to the economic and environmental issue for furfural production compared to the organic phase. There is a limitation that the efficiency in aqueous phase is very low due to the further rehydration of furfural and the formation of oligomeric species resulted from consecutive condensation reactions between furfural with itself and with xylose. These side reactions will be eliminated by adding organic solvent and a salt to the reaction system which are already explained in section 2.3. A brief



review on dehydration of carbohydrates is presented in the below [Table 4](#). Different feed stocks, reactor systems, catalysts, solvents used and process conditions are included in this [Table 4](#).

<b>Table 4.</b> Literature review on production of furfural.					
<b>Feedstock</b>	<b>Catalyst</b>	<b>Solvent</b>	<b>Reactor</b>	<b>Process conditions</b>	<b>Ref</b>
Xylose	Zirconium phosphate	-	Biphasic reactor	433K	[80]
Xylose	Amberlyst	Deionized water	Biphasic reactor	448K, 8 bar	[81]
Xylose	Zeolite with Si/Al ratio 15	-	Aqueous phase reactor	443K, 5 MPa, 150 min	[82]
Xylose	Sulphuric acid	DMSO	Aqueous phase reactor	443-458K, 3h	[83]
Xylose & Xylan	HCl, CrCl <sub>2</sub> , CrCl <sub>3</sub>	[EMIM]Cl	Biphasic reactor	373-413K, 2h	[84]
Xylose	Supported Nb <sub>2</sub> O <sub>5</sub>	Toluene	Biphasic reactor	433K, 24 h, 15bar	[85]
Xylose	Sulphuric acid or formic acid	-	Batch reactor	433-453K, 20-80 min	[86]
Xylose	SO <sub>4</sub> <sup>2-</sup> /ZrO <sub>2</sub> /SBA-15	Toluene	Biphasic reactor	433K, 4h	[87]
Xylose	Heteropolyacid	DMSO	Aqueous phase reactor	413K, 4h	[88]
Xylose	Zeolite MCM	Toluene	Biphasic reactor	443K,	[89]
Xylose	Cesium salt of 12-tungstophosphoric acid	Toluene	Biphasic reactor	433K, 4h	[90]
Xylose	Sulfuric acid	Toluene	Biphasic reactor	450K, 4.8h	[91]
Xylose	Silica MCM-41	Toluene	Biphasic reactor	413K, 4h	[92]
Xylan	Silicoaluminophosphate	Toluene	Biphasic reactor	443K,	[93]
Xylose	Montmorillonite with tin ions	2-sec-butylphenol	Biphasic reactor	453K,30min	[94]

Xylan	SnCl <sub>4</sub>	2-MTHF	Biphasic reactor	423K, 120min	[95]
Xylose	Zeolite NU-6(1)	Toluene	Biphasic reactor	443K, 4h	[96]
Xylose	Formic acid	Ethanol	Aqueous phase reactor	443-463K, 2h	[97]
Xylose or Xylan	FeCl <sub>3</sub> .6H <sub>2</sub> O	-	Aqueous phase reactor	458K, 100min	[98]
Xylose	Amberlyst	Toluene	Biphasic reactor	453K, 10bar 20 h	[99]
Xylose	SnO <sub>2</sub>	DMSO	Biphasic reactor	373K,	[100]
Xylose	Vanadium phosphates	Toluene	Biphasic reactor	443K, 4h	[101]
Xylose	Arenesulfonic SBA-15	Toluene	Biphasic reactor	433K, 15 bar 20 h	[102]
Xylose & Xylan	HCl	Water	Aqueous phase reactor	453K, 20min	[103]
Xylose & Xylan	Metal chloride	MIBK	Biphasic reactor	353-373K, 30min	[104]
Xylose	Niobium phosphate	Toluene	Biphasic reactor	483K, 1h	[105]
Xylose	Sulphated zirconia	Toluene	Biphasic reactor	433K, 3h	[106]
Xylose	Sn-Beta Zeolite	Tetraethyl ammonium	Biphasic reactor	393K, 115min	[107]
Xylose	HCl-CrCl <sub>3</sub>	Water	Aqueous phase reactor	418K, 120min	[108]
Xylose	Aluminium and hafnium pillared clays	Deionized water	Aqueous phase reactor	413-443K	[109]
Xylose	SO <sub>4</sub> <sup>2-</sup> /TiO <sub>2</sub> -ZrO <sub>2</sub> /La <sup>+3</sup>	DMI	Biphasic reactor	453K, 6h	[110]

Xylose	Zeolite H-Beta and TUD-1	Toluene	Biphasic reactor	443K	[111]
Xylose	Amberlyst-15	Cyclohexane	Biphasic reactor	408K, 6h, 2.5 MPa	[112]
Xylose	Sulfonated grapheme oxide	DMSO or Toluene	Biphasic reactor	473K, 20 min	[113]
Xylose	Zirconium-Tungsten mixed oxides	Toluene	Biphasic reactor	443K, 2h	[114]
Xylose	TiO <sub>2</sub> /RGO(reduces grapheme oxide)	Toluene	Biphasic reactor	443K, 5h	[115]
Xylose	SBA-15	DMSO	Biphasic reactor	443K, 10bar, 20h	[116]
Xylose	Silicasupported 12-tungstophoric acid	DMSO	Biphasic reactor	433K, 4h	[117]
Xylose	Silicoaluminophosphate	Toluene	Biphasic reactor	443K, 6h	[118]
Xylose	ZSM-5 Zeolite	DMSO	Batch reactor	473K, 50 bar	[119]
Xylose	Niobium hydroxide acid	Acetic acid and water solution	Aqueous phase reactor	423K, 6h	[120]
Xylose	Niobium oxide	Cyclopentyl Methylether	Biphasic reactor	453K,	[121]
Xylose	SnCl <sub>4</sub>	DMSO	Aqueous phase reactor	413, 4h	[122]

There are different feed stocks, catalysts and solvents available for the production of Furfural in literature. Martyn et al. demonstrated that heteropolyacids are active catalysts for the homogeneous liquid phase dehydration of xylose to furfural [88]. Margarida et al. investigated under batch mode in the presence of MCM-22 zeolite, he concluded that decreasing the Si/Al ratio increases the catalytic activity without affecting the selectivity of furfural [89]. Ordonsky et al. compared different organic solvents DMSO, MTHF and 1-butanol in presence of amberlyst [112]. In presence of organic phase, catalyst will suppress the hydration of xylose to xylitol. Mechanism of the dehydration of xylose is shown in Fig. 8. The exact mechanism of the furfural

forming reaction has not been unequivocally established in literature [97]. Several side reactions lead to the decrease of furfural yield, so in this project mechanism of the reaction will be established by eliminating side reactions.

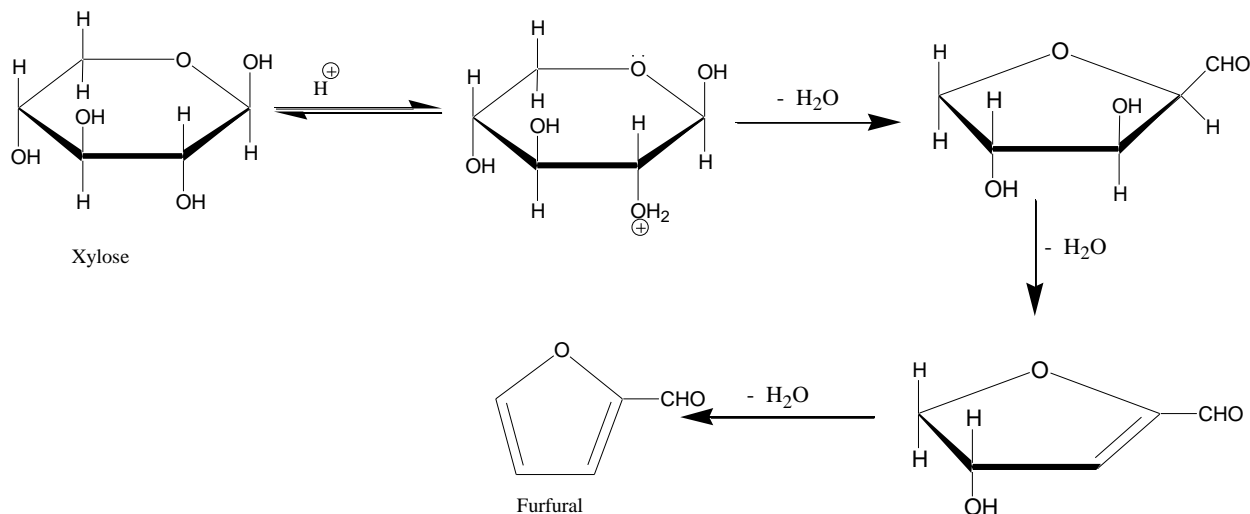

**Fig. 8.** Mechanism of dehydration of xylose. [97]

### 3. Objectives

The main objective of the present work is the catalytic dehydration of carbohydrates in a batch reactor to produce platform chemicals such as HMF and furfural in a biphasic reactor. Other than these some specific objectives are given below.

1. Analysis of organic phase using GC (gas chromatograph) and GC-MS to identify and quantify the products.
2. Study the effect of various reaction parameters such as temperature, salt concentration and fructose concentration on product concentration in the organic phase.

### 4. Experimental

#### 4.1. Materials

Fructose (extra pure) glucose (anhydrous extra pure), methyl isobutyl ketone (pure,  $\geq 98\%$ ) and seralite cation exchange resin (stranded grade) were purchased from Sisco Research Laboratories Pvt. Ltd. Seralite is a strongly acidic cation exchange resin (has ion exchange capacity = 5 meq/g

and active group is sulphonic) formed by copolymerising styrene with divinylbenzene and sulphonating the product. Dimethyl sulfoxide (DMSO, purity  $\geq 99\%$ ) and butanol ( $\geq 99\%$ ) were obtained from Merck Specialties Pvt. Limited. All chemicals were used without further purification.

#### 4.2. Experimental setup and procedure

Dehydration of carbohydrates was performed in a batch reactor containing a magnetic stirrer. The experimental set up is shown in Fig. 9. The reactor consists of a condenser with inlet and outlet valves and a round neck bottom flask submerged in an oil bath which is placed on top of an digital stirring hot plate. A known volume of aqueous and organic phases was charged into the flask. In this experiment, aqueous solution was composed of carbohydrates (fructose/xylose), salt, water, aqueous solvent such as DMSO and organic phase consists of mixture of solvents such as MIBK and butanol. The reactor was heated to desired reaction temperature while stirring at constant speed. Product samples were collected for every 60 min and separated the organic phase from aqueous phase. Organic phase of each sample was centrifuged and then analyzed. After completing the reaction, reactor was cooled using ice bath then the phases were separated and analyzed.

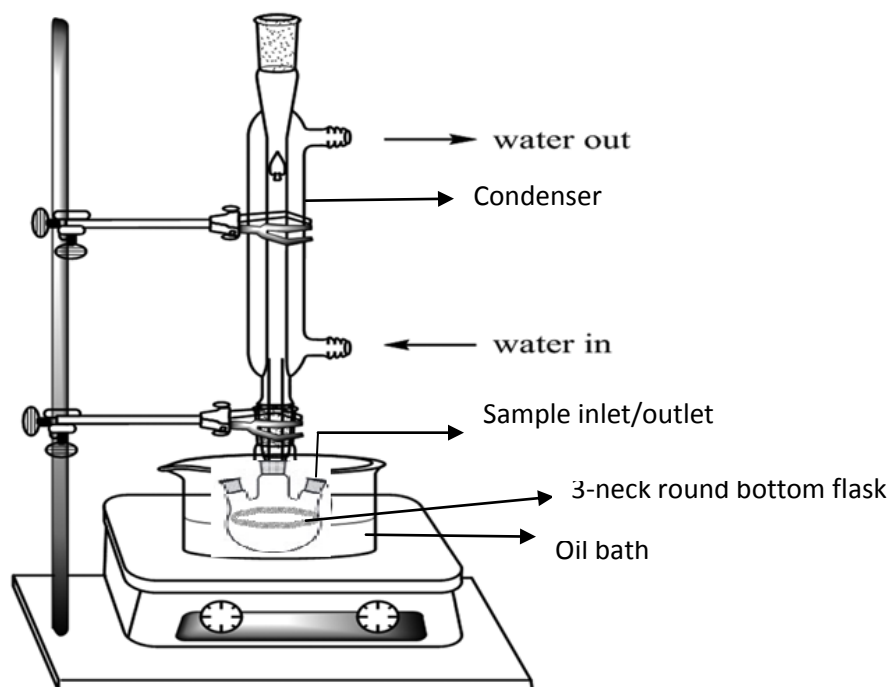

Fig. 9. Experimental setup (batch reactor).

### 4.3. Product analysis

The separated organic phase was first centrifuged and then product in that phase identified with a gas chromatograph (Shimadzu, GC-2010) equipped with a mass spectrometer (MS) and quantified by GC equipped with a flame ionization detector (FID) which is connected to a capillary column ZB-5HT (30m × 0.32mm × 0.10μm) using nitrogen as carrier gas. Injector and detector temperature was maintained at 573K and 613K respectively. Initially column was kept at 323K for 4 min, then increased to 518K with a ramp rate of 10 K/min and maintained for 2 min.

## 5. Results and discussion

The dehydration of carbohydrates was done in a batch reactor using a mixture of organic solvents (MIBK and butanol), aqueous solvent (DMSO), water, inorganic salt NaCl in presence of cation exchange resin as a catalyst in the wide range of temperatures (353-393K) and concentrations of NaCl (0-8 gm). 5-HMF was identified as the product of dehydration of fructose and glucose, furfural was identified in the dehydration of xylose. Other than these products, mixture of solvents MIBK, butanol and DMSO were also observed in the organic phase.

### 5.1. Identification of product

After completing the reaction, mixture was cooled and organic and aqueous phases were separated out. Using gas chromatograph organic phase was analyzed, typical chromatograms were shown in the [Fig. 10](#) and [Fig. 11](#) for dehydration of fructose and glucose respectively. First three peaks represents the solvents butanol, MIBK and DMSO respectively. Compared to the glucose, dehydration of fructose chromatogram has more HMF concentration. So, further research has done using fructose as feed to understand effect of temperature, salt concentration and fructose concentration on product concentration. Similarly, [Fig. 12](#) represents chromatogram of dehydration of xylose which can produce furfural.

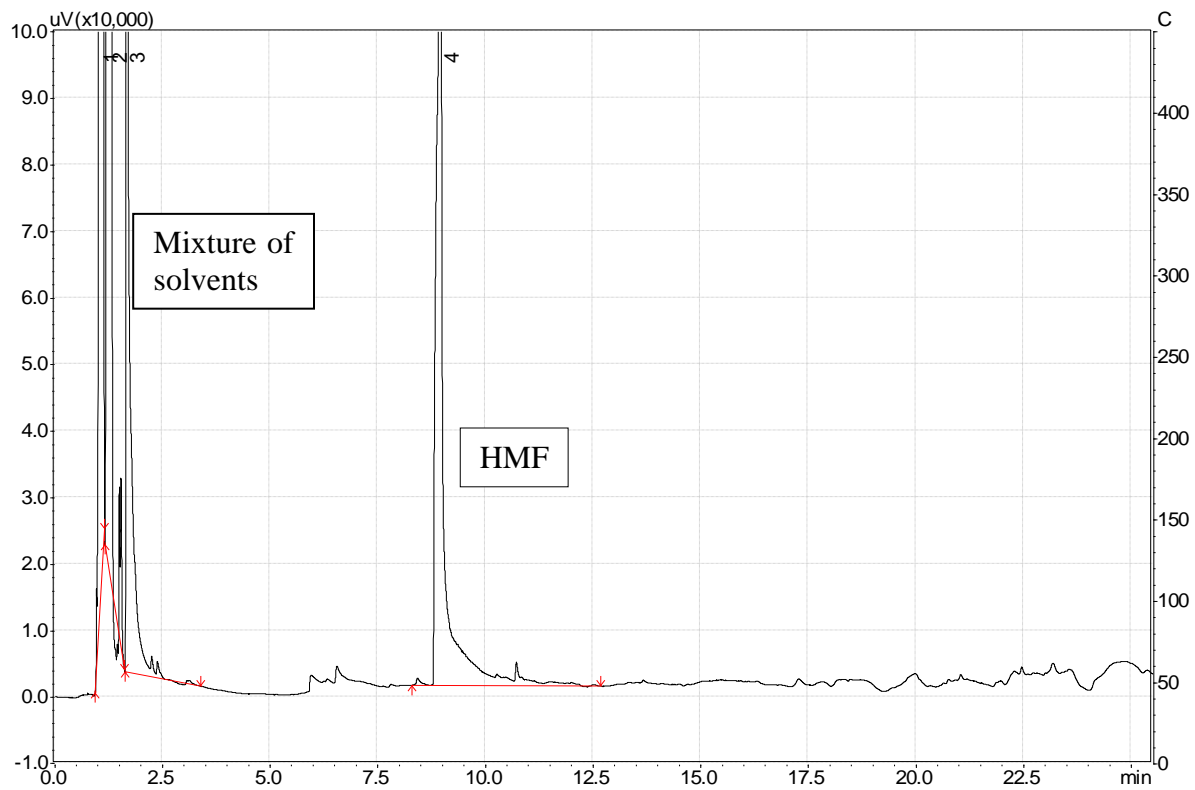

**Fig. 10.** Chromatogram of dehydration of fructose over cation exchange resin catalyst.  
Reaction conditions: atmospheric pressure, catalyst loading = 5 gm, fructose = 10 gm, salt = 8 gm, temperature = 373K.

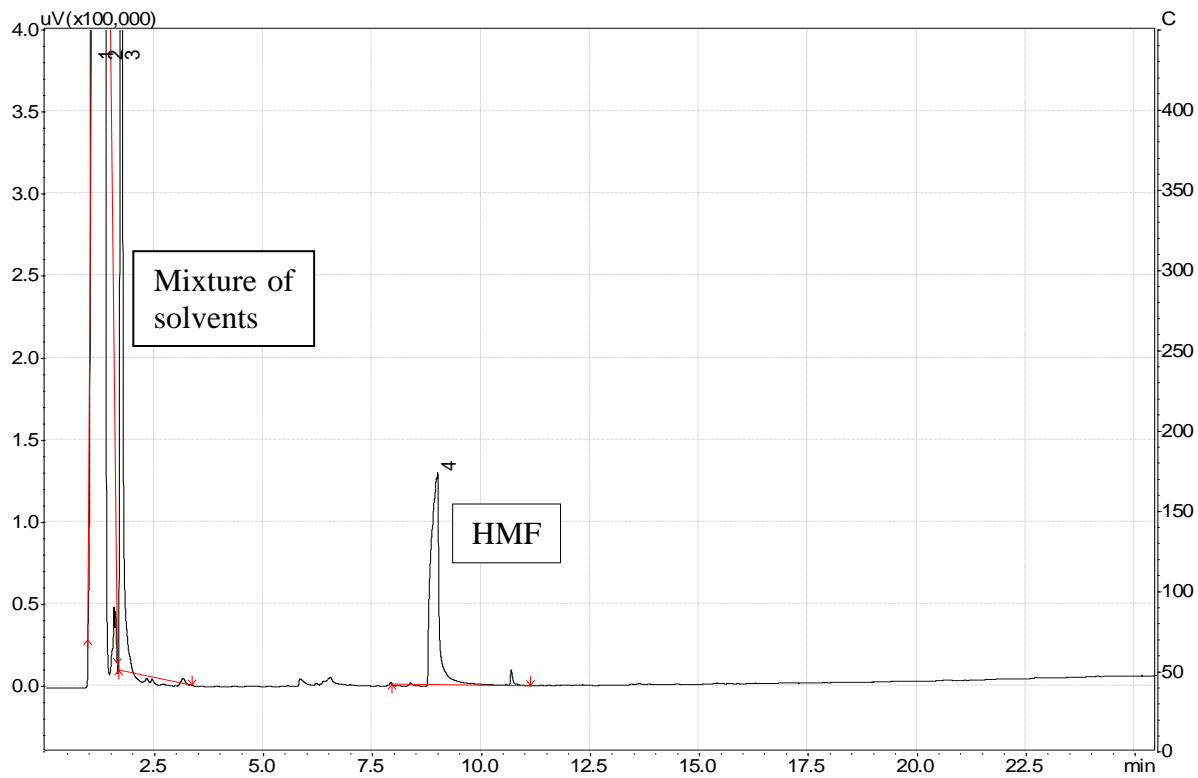

**Fig. 11.** Chromatogram of dehydration of glucose over cation exchange resin catalyst.

Reaction conditions: atmospheric pressure, catalyst loading = 5 gm, glucose = 10 gm, salt = 8 gm, temperature = 373 K.



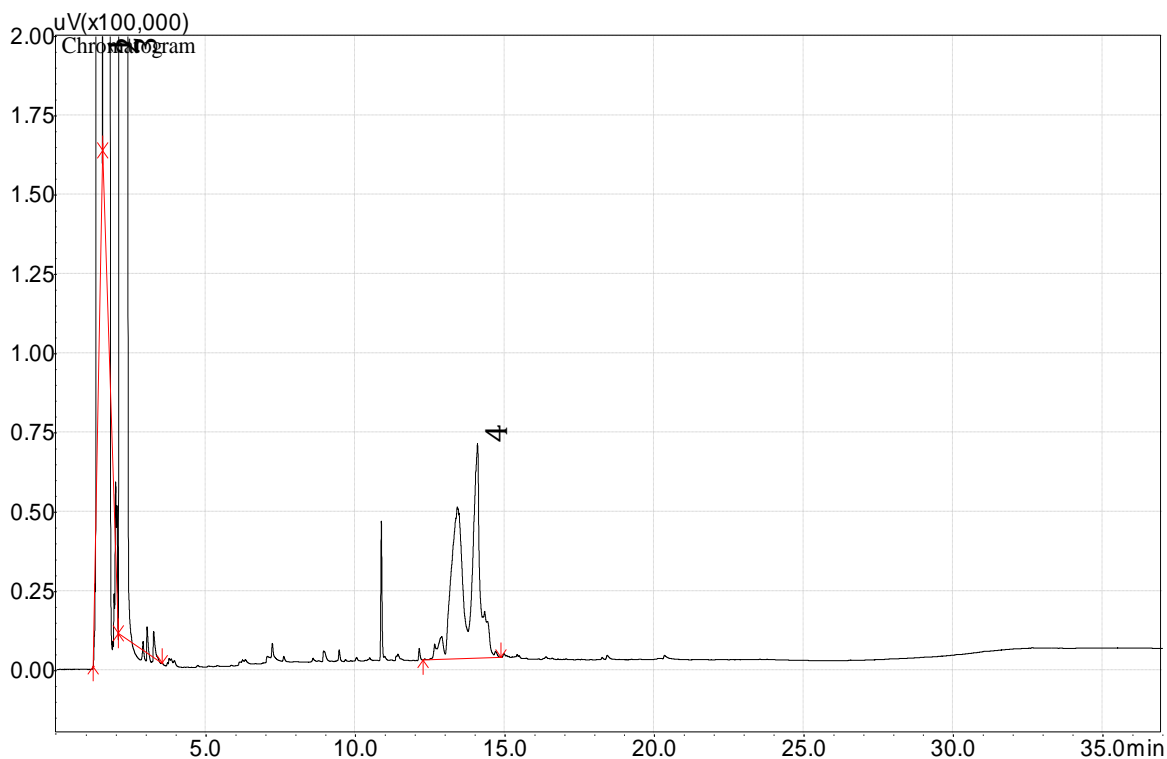

**Fig. 12.** Chromatogram of dehydration of xylose over cation exchange resin catalyst.

Reaction conditions: atmospheric pressure, catalyst loading = 5 gm, xylose = 10 gm, salt = 0 gm, temperature = 353 K.

## 5.2. Effects of salt concentration

The effect of salt concentration on product concentration was studied at different salt concentrations of 0 gm, 5 gm and 8 gm for 15 gm of fructose over cation exchange resin catalyst and the results are shown in the [Table 5](#) and [Fig. 13](#). As observed from the table, product concentration was increased by increasing salt concentration from 0 gm to 5 gm. As explained earlier, adding salt to the reaction system will increase the partition coefficient, this results more product in organic phase compared to without salt system. The main reason behind increasing the product in organic phase is, when salt was added to the system it will affect the interaction between product formed and water. As a consequence, product extracted to organic phase easily with other solvents.

**Table 5.** Effects of salt concentration.

Reaction time, min	Product concentration, wt%		
	Salt concentration		
	0 gm	5 gm	8 gm
60	0.06296	1.04413	0.39518
120	0.17422	1.21192	0.83156
180	0.31156	1.52900	1.33490
240	0.44096	1.43183	1.53835
300	0.54558	2.01613	1.99786
360	0.56339	2.31520	2.10619

Reaction conditions: atmospheric pressure, temperature = 373 K, catalyst = cation exchange resin, catalyst loading = 5 gm, fructose concentration = 15 gm.

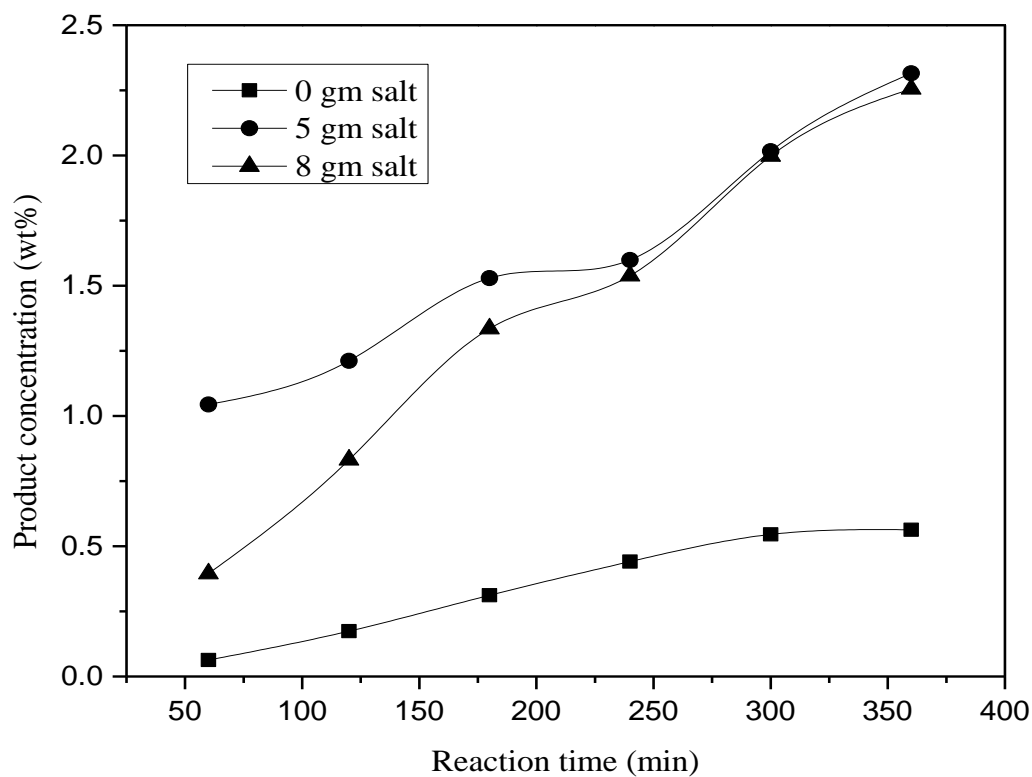
**Fig. 13.** Effects of salt concentration.

Reaction conditions: atmospheric pressure, temperature = 373 K, catalyst = cation exchange resin, fructose = 15 gm, catalyst loading = 5 gm.

### 5.3. Effects of fructose concentration

The effect of fructose concentration on product concentration was studied at different fructose concentrations of 7 gm, 10 gm and 15 gm at 373K of temperature over cation exchange resin catalyst and the results are shown in the [Table 6](#). Results indicate that increasing the fructose concentration from 7 gm to 10 gm, increases the product concentration. Similarly, further increasing the concentration to 15 gm, product concentration also increased. Effect of fructose concentration clearly explained in [Fig. 14](#).

<b>Table 6.</b> Effects of fructose concentration.			
Reaction time, min	Product concentration, wt%		
	Fructose concentration		
	7 gm	10 gm	15 gm
60	0.00316	0.2537	0.39518
120	0.0227	0.64013	0.83156
180	0.06054	1.15606	1.33490
240	0.08509	1.2398	1.53835
300	0.11631	1.73015	1.99786
360	0.15475	2.06943	2.20619

Reaction conditions: atmospheric pressure, temperature = 373 K, catalyst = cation exchange resin, catalyst loading = 5 gm.

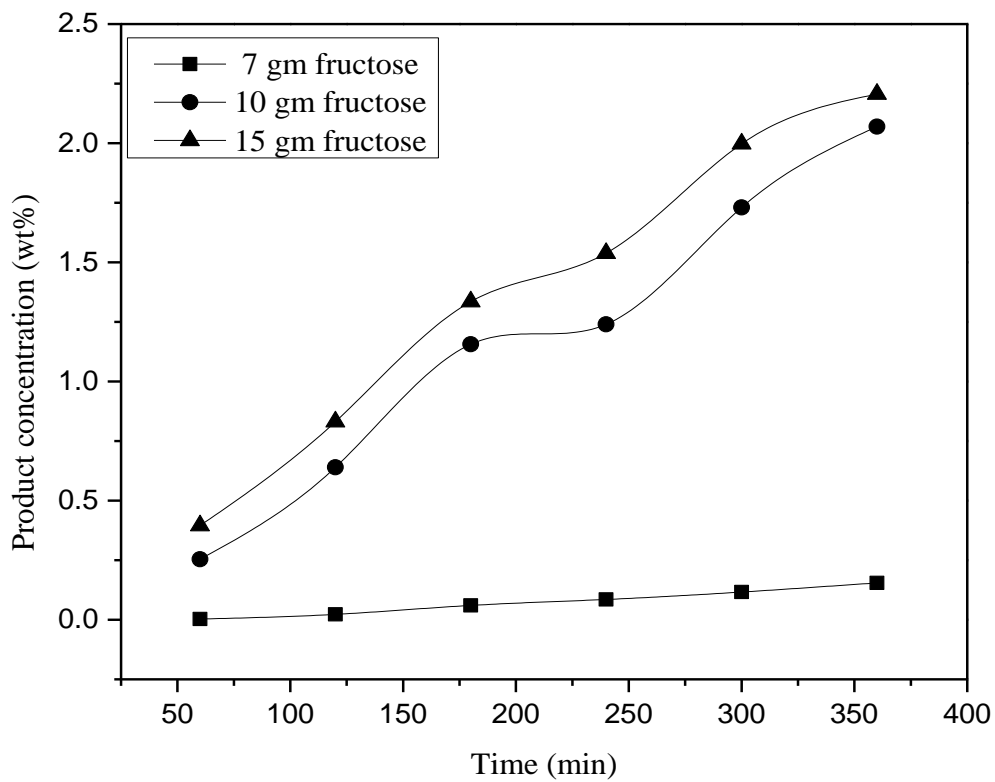

**Fig. 14.** Effects of fructose concentration.

Reaction conditions: atmospheric pressure, temperature = 373 K, catalyst = cation exchange resin, catalyst loading = 5 gm, fructose concentration = 7 gm, 10 gm, 15 gm.

#### 5.4. Effects of temperature

The effect of temperature on product concentration was studied at different temperatures 353 K-373 K for 7 and 15 gm of fructose over cation exchange resin catalyst. The results are shown in the [Tables 7-8](#). For 7 gm of fructose, the product concentration increased by increasing the temperature from 353 to 373 K. Similarly in the other case using 15 gm of fructose, product concentration increased when increasing the temperature from 353 to 373K as shown in the [Fig. 15](#) and [Fig.16](#). These results indicate that increasing the temperature, increases the product concentration.

**Table 7.** Effects of temperature for dehydration of fructose.

Reaction time, min	Product concentration, wt%	
	Temperature, K	
	353K	373K
60	0.003	0.273
120	0.022	0.582
180	0.060	0.615
240	0.085	0.844
300	0.116	1.001
360	0.154	1.160
420	0.181	1.198
480	0.188	1.584

Reaction conditions: atmospheric pressure, catalyst = cation exchange resin, catalyst loading = 5 gm, fructose concentration = 7 gm.

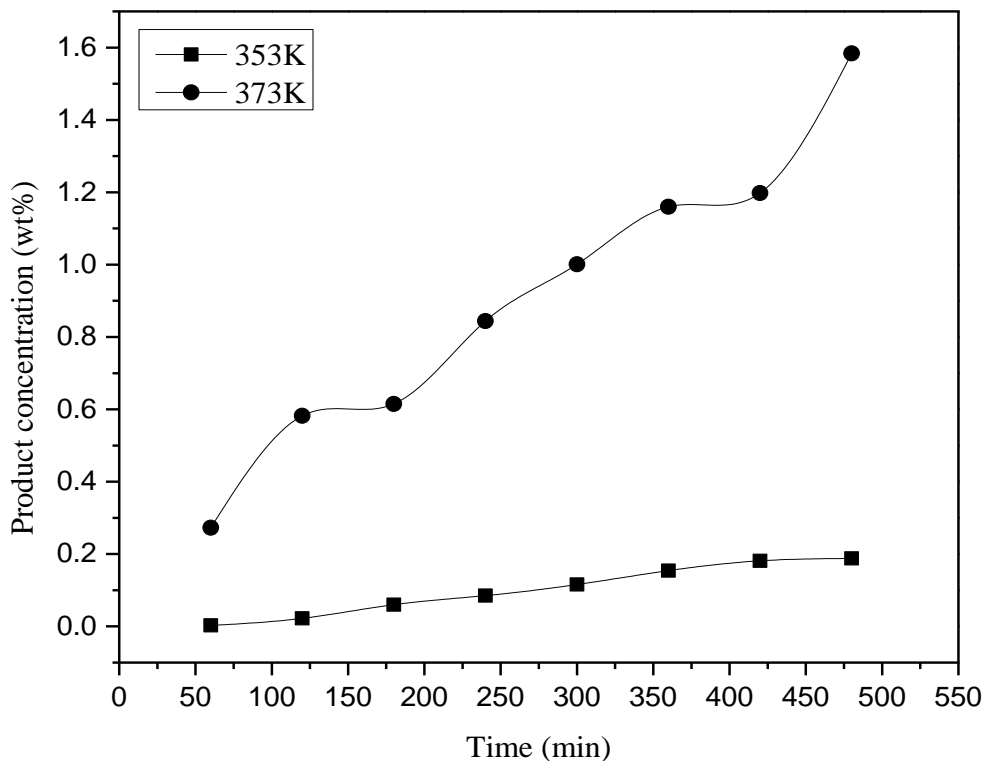

**Fig. 15.** Effects of temperature for dehydration of fructose.

Reaction conditions: atmospheric pressure, catalyst= cation exchange resin, catalyst loading = 5 gm, fructose = 7 gm.

**Table 8.** Effects of temperature for dehydration of fructose.

Reaction time, min	Product concentration, wt%	
	Temperature, K	
	353K	373K
60	0.3247	0.3951
120	0.5234	0.8315
180	1.0096	1.3349
240	1.1580	1.5383
300	1.2715	1.9978
360	1.3623	2.1061

Reaction conditions: atmospheric pressure, catalyst= cation exchange resin, catalyst loading = 5 gm, fructose concentration = 15 gm.

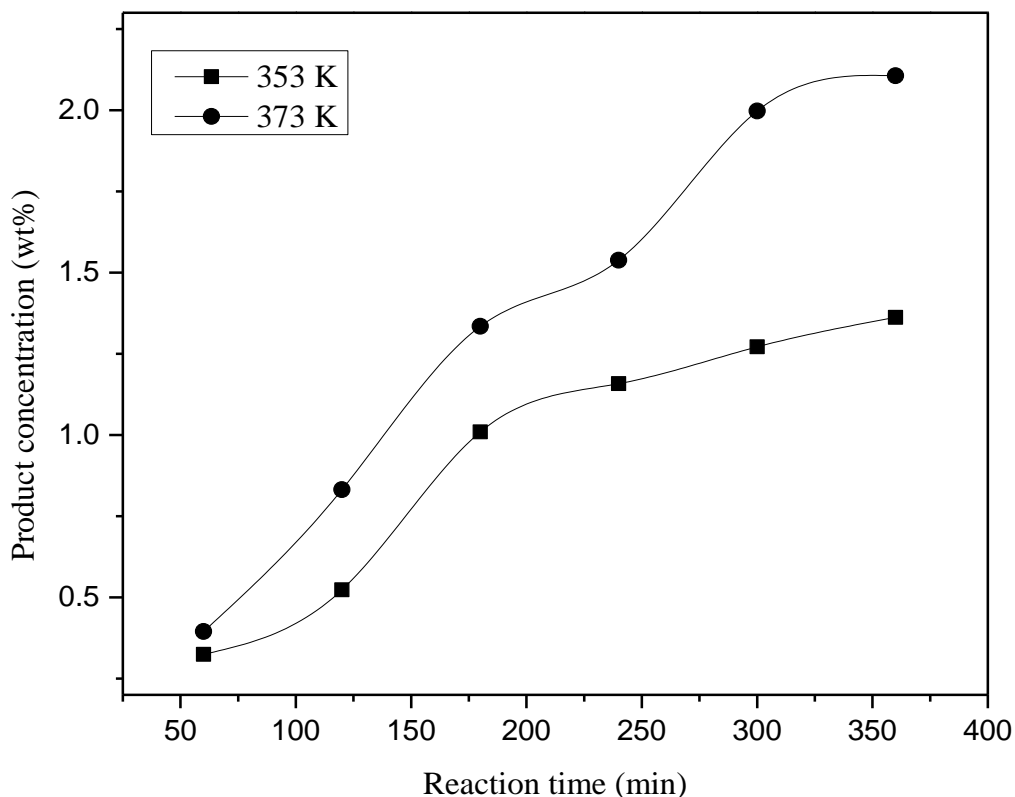

**Fig. 16.** Effects of temperature for dehydration of fructose.

Reaction conditions: atmospheric pressure, catalyst = cation exchange resin, catalyst loading = 5 gm, fructose = 15 gm.

## 6. Conclusions

The production of 5-HMF and furfural by dehydration of carbohydrates is very important because of their applications in the production of fine chemicals, polymers and also as starting materials for new products. These compounds became alternatives to oil derived chemicals. In the present work, dehydration of carbohydrates was studied in a batch reactor at atmospheric pressure. Reaction mechanism of dehydration of carbohydrates was also explained. This work

focused on elimination of unwanted side reactions to increase the product concentration by adding a mixture of organic solvents and increasing the feed composition. Effect of salt was also studied by varying the salt concentration and it is concluded that salt played a major role in increasing the product concentration. The optimized reaction conditions including reaction temperature, extraction solvent loading and fructose concentrations were obtained for dehydration of fructose in a biphasic system. Increase in the product concentration was observed by increasing the fructose concentration.

## 7. Future work

Future work should be done to analyze the aqueous phase and also to quantify the product in aqueous phase using HPLC (high pressure liquid chromatography). Different types of solid acid catalysts should be studied and optimized the catalyst loading. Based on the results obtained by optimization, the best catalyst should be prepared and characterized. The spent catalyst should be regenerated and used for reusability studies.

## 5. References

- [1] A. A. Rosatella, S. P. Simeonov, R. F. M. Frade, and C. A. M. Afonso, "5-Hydroxymethylfurfural (HMF) as a building block platform: Biological properties, synthesis and synthetic applications," *Green Chem.*, vol. 13, no. 4, p. 754, 2011.
- [2] O. Abdulmalik, M. K. Safo, Q. Chen, J. Yang, C. Brugnara, K. Ohene-Frempong, D. J. Abraham, and T. Asakura, "5-Hydroxymethyl-2-furfural modifies intracellular sickle haemoglobin and inhibits sickling of red blood cells," *Br. J. Haematol.*, vol. 128, no. 4, pp. 552–561, 2005.
- [3] Y. Qiao, N. Theyssen, and Z. Hou, "Acid-Catalyzed Dehydration of Fructose to 5-(Hydroxymethyl)furfural," *Recycl. Catal.*, vol. 2, no. 1, pp. 36–60, 2015.
- [4] K. J. Zeitsch, *The Chemistry and Technology of Furfural and its Many By-Products*. Elsevier, 2000.
- [5] K. Yan, G. Wu, T. Lafleur, and C. Jarvis, "Production, properties and catalytic hydrogenation of furfural to fuel additives and value-added chemicals," *Renew. Sustain. Energy Rev.*, vol. 38, pp. 663–676, 2014.
- [6] N. V. Plechkova and K. R. Seddon, "Applications of ionic liquids in the chemical industry.," *Chem. Soc. Rev.*, vol. 37, no. 1, pp. 123–150, 2008.
- [7] S. B. Kim, S. J. You, Y. T. Kim, S. Lee, H. Lee, K. Park, and E. D. Park, "Dehydration of D-xylulose into furfural over H-zeolites," *Korean J. Chem. Eng.*, vol. 28, no. 3, pp. 710–



- 716, 2011.
- [8] Y. Román-leshkov, “Phase Modifiers Promote Efficient Production of HMF from fructose.pdf,” vol. 1933, no. 2006, 2012.
- [9] S. H. Mushrif, S. Caratzoulas, and D. G. Vlachos, “Understanding solvent effects in the selective conversion of fructose to 5-hydroxymethyl-furfural: a molecular dynamics investigation,” *Phys. Chem. Chem. Phys.*, vol. 14, no. 8, p. 2637, 2012.
- [10] F. Liu, S. Sivorththaman, and Z. Tan, “Solvent extraction of 5-HMF from simulated hydrothermal conversion product,” *Sustain. Environ. Res.*, vol. 24, no. 2, pp. 149–157, 2014.
- [11] Y. Román-Leshkov and J. a. Dumesic, “Solvent effects on fructose dehydration to 5-hydroxymethylfurfural in biphasic systems saturated with inorganic salts,” *Top. Catal.*, vol. 52, no. 3, pp. 297–303, 2009.
- [12] R. J. Van Putten, J. C. Van Der Waal, E. De Jong, C. B. Rasrendra, H. J. Heeres, and J. G. De Vries, “Hydroxymethylfurfural, a versatile platform chemical made from renewable resources,” *Chem. Rev.*, vol. 113, no. 3, pp. 1499–1597, 2013.
- [13] E. Nikolla, Y. Román-Leshkov, M. Moliner, and M. E. Davis, “‘One-pot’ synthesis of 5-(hydroxymethyl)furfural from carbohydrates using tin-beta zeolite,” *ACS Catal.*, vol. 1, no. 4, pp. 408–410, 2011.
- [14] F. K. Kazi, A. D. Patel, J. C. Serrano-Ruiz, J. a. Dumesic, and R. P. Anex, “Techno-economic analysis of dimethylfuran (DMF) and hydroxymethylfurfural (HMF) production from pure fructose in catalytic processes,” *Chem. Eng. J.*, vol. 169, no. 1–3, pp. 329–338, 2011.
- [15] A. Toftgaard, R. Ringborg, T. Grotkjær, S. Pedersen, and J. M. Woodley, “Synthesis of 5-hydroxymethylfurfural ( HMF ) by acid catalyzed dehydration of glucose – fructose mixtures,” vol. 273, pp. 455–464, 2015.
- [16] F. Yang, Q. Liu, X. Bai, and Y. Du, “Conversion of biomass into 5-hydroxymethylfurfural using solid acid catalyst,” *Bioresour. Technol.*, vol. 102, no. 3, pp. 3424–3429, 2011.
- [17] Q. Zhao, L. Wang, S. Zhao, X. Wang, and S. Wang, “High selective production of 5-hydroxymethylfurfural from fructose by a solid heteropolyacid catalyst,” *Fuel*, vol. 90, no. 6, pp. 2289–2293, 2011.
- [18] Y. Yang, X. Xiang, D. Tong, C. Hu, and M. M. Abu-Omar, “One-pot synthesis of 5-hydroxymethylfurfural directly from starch over SO<sub>4</sub><sup>2-</sup>/ZrO<sub>2</sub>-Al<sub>2</sub>O<sub>3</sub> solid catalyst,” *Bioresour. Technol.*, vol. 116, pp. 302–306, 2012.
- [19] Y. J. Pagán-Torres, T. Wang, J. M. R. Gallo, B. H. Shanks, and J. a. Dumesic, “Production of 5-hydroxymethylfurfural from glucose using a combination of lewis and brønsted acid catalysts in water in a biphasic reactor with an alkylphenol solvent,” *ACS Catal.*, vol. 2, no. 6, pp. 930–934, 2012.
- [20] I. Jiménez-Morales, M. Moreno-Recio, J. Santamaría-González, P. Maireles-Torres, and A. Jiménez-López, “Production of 5-hydroxymethylfurfural from glucose using aluminium doped MCM-41 silica as acid catalyst,” *Appl. Catal. B Environ.*, vol. 164, pp. 70–76, 2015.

- [21] I. Alam, S. De, B. Singh, B. Saha, and M. M. Abu-omar, "Applied Catalysis A : General Titanium hydrogenphosphate: An efficient dual acidic catalyst for 5-hydroxymethylfurfural ( HMF ) production," vol. 486, pp. 42–48, 2014.
- [22] Y. Yang, C. Hu, and M. M. Abu-Omar, "Conversion of carbohydrates and lignocellulosic biomass into 5-hydroxymethylfurfural using  $\text{AlCl}_3 \cdot 6\text{H}_2\text{O}$  catalyst in a biphasic solvent system," *Green Chem.*, vol. 14, no. 2, p. 509, 2012.
- [23] Q. Ren, Y. Huang, H. Ma, J. Gao, and J. Xu, "Catalytic conversion of carbohydrates to 5-hydroxymethylfurfural promoted by metal halides," *Chinese J. Catal.*, vol. 35, no. 4, pp. 496–500, 2014.
- [24] Y. Shen, J. Sun, Y. Yi, M. Li, B. Wang, F. Xu, and R. Sun, "Bioresource Technology  $\text{InCl}_3$  -catalyzed conversion of carbohydrates into 5-hydroxymethylfurfural in biphasic system," vol. 172, pp. 457–460, 2014.
- [25] V. V Ordonsky, V. L. Sushkevich, J. C. Schouten, J. Van Der Schaaf, and T. A. Nijhuis, "Glucose dehydration to 5-hydroxymethylfurfural over phosphate catalysts," vol. 300, pp. 37–46, 2013.
- [26] G. Tian, X. Tong, Y. Cheng, and S. Xue, "Tin-catalyzed efficient conversion of carbohydrates for the production of 5-hydroxymethylfurfural in the presence of quaternary ammonium salts," *Carbohydr. Res.*, vol. 370, pp. 33–37, 2013.
- [27] X. Qi, M. Watanabe, T. M. Aida, and R. L. Smith, "Sulfated zirconia as a solid acid catalyst for the dehydration of fructose to 5-hydroxymethylfurfural," vol. 10, pp. 1771–1775, 2009.
- [28] Y. Wang, X. Tong, Y. Yan, S. Xue, and Y. Zhang, "Efficient and selective conversion of hexose to 5-hydroxymethylfurfural with tin – zirconium-containing heterogeneous catalysts," vol. 50, pp. 38–43, 2014.
- [29] H. Yan, Y. Yang, D. Tong, X. Xiang, and C. Hu, "Catalytic conversion of glucose to 5-hydroxymethylfurfural over  $\text{SO}_4^{2-} / \text{ZrO}_2$  and  $\text{SO}_4^{2-} / \text{ZrO}_2 - \text{Al}_2\text{O}_3$  solid acid catalysts," vol. 10, pp. 1558–1563, 2009.
- [30] L. Li, J. Ding, J.-G. Jiang, Z. Zhu, and P. Wu, "One-pot synthesis of 5-hydroxymethylfurfural from glucose using bifunctional  $[\text{Sn}, \text{Al}]$ -Beta catalysts," *Chinese J. Catal.*, vol. 36, no. 6, pp. 820–828, 2015.
- [31] Z. Yuan, C. Xu, S. Cheng, and M. Leitch, "Catalytic conversion of glucose to 5-hydroxymethyl furfural using inexpensive co-catalysts and solvents," *Carbohydr. Res.*, vol. 346, no. 13, pp. 2019–2023, 2011.
- [32] J. Zhang, A. Das, R. S. Assary, L. A. Curtiss, and E. Weitz, "Applied Catalysis B : Environmental acid catalysts," pp. 26–34, 2014.
- [33] C. Wang, L. Fu, X. Tong, Q. Yang, and W. Zhang, "Efficient and selective conversion of sucrose to 5-hydroxymethylfurfural promoted by ammonium halides under mild conditions," *Carbohydr. Res.*, vol. 347, no. 1, pp. 182–185, 2012.
- [34] P. Daorattanachai, P. Khemthong, N. Viriya-Empikul, N. Laosiripojana, and K. Faungnawakij, "Conversion of fructose, glucose, and cellulose to 5-hydroxymethylfurfural by alkaline earth phosphate catalysts in hot compressed water," *Carbohydr. Res.*, vol. 363, pp. 58–61, 2012.

- [35] a. Chareonlimkun, V. Champreda, a. Shotipruk, and N. Laosiripojana, "Reactions of C5 and C6-sugars, cellulose, and lignocellulose under hot compressed water (HCW) in the presence of heterogeneous acid catalysts," *Fuel*, vol. 89, no. 10, pp. 2873–2880, 2010.
- [36] S. Jia, Z. Xu, and Z. C. Zhang, "Catalytic conversion of glucose in dimethylsulfoxide / water binary mix with chromium trichloride : Role of water on the product distribution," vol. 254, pp. 333–339, 2014.
- [37] T. Caruso and E. Vasca, "Electrogenerated acid as an efficient catalyst for the preparation of 5-hydroxymethylfurfural," *Electrochem. commun.*, vol. 12, no. 9, pp. 1149–1153, 2010.
- [38] L. Semidey-Flecha, L. Semidey-Flecha, S. Hao, S. Hao, D. Sholl, and D. Sholl, "Journal of the Taiwan Institute of Chemical Engineers," *Chbe.Gatech.Edu*, vol. 40, pp. 333–336, 2009.
- [39] C. Moreau, R. Durand, S. Razigade, J. Duhamet, P. Faugeras, P. Rivalier, P. Ros, and G. Avignon, "Dehydration of fructose to 5-hydroxymethylfurfural over H-mordenites," *Appl. Catal. A Gen.*, vol. 145, no. 1–2, pp. 211–224, 1996.
- [40] R. F. Petry and J. C. Hill, "of ' Y," vol. 37, no. 6, pp. 11–19, 1988.
- [41] J. Liu, Y. Tang, K. Wu, C. Bi, and Q. Cui, "Conversion of fructose into 5-hydroxymethylfurfural (HMF) and its derivatives promoted by inorganic salt in alcohol," *Carbohydr. Res.*, vol. 350, pp. 20–24, 2012.
- [42] F. Benvenuti, C. Carlini, P. Patrono, A. M. Raspolli Galletti, G. Sbrana, M. A. Massucci, and P. Galli, "Heterogeneous zirconium and titanium catalysts for the selective synthesis of 5-hydroxymethyl-2-furaldehyde from carbohydrates," *Appl. Catal. A Gen.*, vol. 193, no. 1–2, pp. 147–153, 2000.
- [43] Q. Cao, X. Guo, J. Guan, X. Mu, and D. Zhang, "A process for efficient conversion of fructose into 5-hydroxymethylfurfural in ammonium salts," *Appl. Catal. A Gen.*, vol. 403, no. 1–2, pp. 98–103, 2011.
- [44] J. S. Kruger, V. Nikolakis, and D. G. Vlachos, "Aqueous-phase fructose dehydration using Brønsted acid zeolites: Catalytic activity of dissolved aluminosilicate species," *Appl. Catal. A Gen.*, vol. 469, pp. 116–123, 2014.
- [45] R. Otomo, T. Yokoi, J. N. Kondo, and T. Tatsumi, "Dealuminated Beta zeolite as effective bifunctional catalyst for direct transformation of glucose to 5-hydroxymethylfurfural," *Appl. Catal. A Gen.*, vol. 470, pp. 318–326, 2014.
- [46] J. Lan and Z. Zhang, "Synthesis of 5-hydroxymethylfurfural from fructose," vol. 23, pp. 200–205, 2015.
- [47] B. Saha, S. De, and M. Fan, "Zr(O)Cl<sub>2</sub> catalyst for selective conversion of biorenewable carbohydrates and biopolymers to biofuel precursor 5-hydroxymethylfurfural in aqueous medium," *Fuel*, vol. 111, pp. 598–605, 2013.
- [48] P. a. Lazaridis, S. Karakoulia, A. Delimitis, S. M. Coman, V. I. Parvulescu, and K. S. Triantafyllidis, "d-Glucose hydrogenation/hydrogenolysis reactions on noble metal (Ru, Pt)/activated carbon supported catalysts," *Catal. Today*, 2015.
- [49] "Applied Catalysis B: Environmental Selective dehydration of glucose to 5-hydroxymethylfurfural on acidic mesoporous tantalum phosphate," vol. 144, pp. 22–28,

- 2014.
- [50] Y. Yang, C. Hu, and M. M. Abu-Omar, "Conversion of glucose into furans in the presence of AlCl<sub>3</sub> in an ethanol-water solvent system," *Bioresour. Technol.*, vol. 116, pp. 190–194, 2012.
- [51] G. Sampath and S. Kannan, "Fructose dehydration to 5-hydroxymethylfurfural: Remarkable solvent influence on recyclability of Amberlyst-15 catalyst and regeneration studies," *Catal. Commun.*, vol. 37, pp. 41–44, 2013.
- [52] L. Ma, I. Jia, X. Guo, and L. Xiang, "Catalytic activity of Ag/SBA-15 for low temperature gas phase selective oxidation of benzyl alcohol to benzaldehyde," *Chinese J. Catal.*, vol. 35, no. 5, pp. 108–119, 2014.
- [53] A. Takagaki, M. Ohara, S. Nishimura, and K. Ebitani, "A one-pot reaction for biorefinery: combination of solid acid and base catalysts for direct production of 5-hydroxymethylfurfural from saccharides.," *Chem. Commun. (Camb.)*, no. 41, pp. 6276–6278, 2009.
- [54] F. Ilgen, D. Ott, D. Kralisch, C. Reil, A. Palmberger, and B. König, "Conversion of carbohydrates into 5-hydroxymethylfurfural in highly concentrated low melting mixtures," *Green Chem.*, vol. 11, no. 12, p. 1948, 2009.
- [55] J. Wang, W. Xu, J. Ren, X. Liu, G. Lu, and Y. Wang, "Efficient catalytic conversion of fructose into hydroxymethylfurfural by a novel carbon-based solid acid," *Green Chem.*, vol. 13, no. 10, p. 2678, 2011.
- [56] J. Wang, J. Ren, X. Liu, J. Xi, Q. Xia, Y. Zu, G. Lu, and Y. Wang, "Direct conversion of carbohydrates to 5-hydroxymethylfurfural using Sn-Mont catalyst," *Green Chem.*, vol. 14, no. 9, p. 2506, 2012.
- [57] X. Qi, M. Watanabe, T. M. Aida, and R. L. Smith, "Selective conversion of D-fructose to 5-hydroxymethylfurfural by ion-exchange resin in acetone/dimethyl sulfoxide solvent mixtures," *Ind. Eng. Chem. Res.*, vol. 47, no. 23, pp. 9234–9239, 2008.
- [58] H. Kimura, M. Nakahara, and N. Matubayasi, "Solvent Effect on Pathways and Mechanisms for D - Fructose Conversion to 5 - Hydroxymethyl-2-furaldehyde : In Situ C NMR Study," 2013.
- [59] C. V. McNeff, D. T. Nowlan, L. C. McNeff, B. Yan, and R. L. Fedie, "Continuous production of 5-hydroxymethylfurfural from simple and complex carbohydrates," *Appl. Catal. A Gen.*, vol. 384, no. 1–2, pp. 65–69, 2010.
- [60] M. H. Tucker, R. Alamillo, A. J. Crisci, G. M. Gonzalez, S. L. Scott, and J. a. Dumesic, "Sustainable solvent systems for use in tandem carbohydrate dehydration hydrogenation," *ACS Sustain. Chem. Eng.*, vol. 1, no. 5, pp. 554–560, 2013.
- [61] A. J. Crisci, M. H. Tucker, J. a. Dumesic, and S. L. Scott, "Bifunctional solid catalysts for the selective conversion of fructose to 5-hydroxymethylfurfural," *Top. Catal.*, vol. 53, no. 15–18, pp. 1185–1192, 2010.
- [62] F. Yang, Y. Li, Q. Zhang, X. Sun, H. Fan, N. Xu, and G. Li, "Selective conversion of cotton cellulose to glucose and 5-hydroxymethyl furfural with SO<sub>4</sub><sup>2-</sup> / M<sub>x</sub>O<sub>y</sub> solid superacid catalyst," vol. 131, pp. 9–14, 2015.

- [63] P. Carniti, A. Gervasini, and M. Marzo, "Absence of expected side-reactions in the dehydration reaction of fructose to HMF in water over niobic acid catalyst," *Catal. Commun.*, vol. 12, no. 12, pp. 1122–1126, 2011.
- [64] H. Ma, F. Wang, Y. Yu, L. Wang, and X. Li, "Autocatalytic Production of 5-Hydroxymethylfurfural from Fructose-Based Carbohydrates in a Biphasic System and Its Purification," *Ind. Eng. Chem. Res.*, p. 150306091358006, 2015.
- [65] T. Wang, J. a. Glasper, and B. H. Shanks, "Kinetics of glucose dehydration catalyzed by homogeneous Lewis acidic metal salts in water," *Appl. Catal. A Gen.*, vol. 498, pp. 214–221, 2015.
- [66] S. Despax, C. Maurer, B. Estrine, J. Le Bras, N. Hoffmann, S. Marinkovic, and J. Muzart, "Fast and efficient DMSO-mediated dehydration of carbohydrates into 5-hydroxymethylfurfural," *Catal. Commun.*, vol. 51, pp. 5–9, 2014.
- [67] N. Jiang, R. Huang, W. Qi, R. Su, and Z. He, "Effect of Formic Acid on Conversion of Fructose to 5-Hydroxymethylfurfural in Aqueous/Butanol Media," *Bioenergy Res.*, vol. 5, no. 2, pp. 380–386, 2012.
- [68] T. Deng, X. Cui, Y. Qi, Y. Wang, X. Hou, and Y. Zhu, "Conversion of carbohydrates into 5-hydroxymethylfurfural catalyzed by ZnCl<sub>2</sub> in water," *Chem. Commun.*, vol. 48, no. 44, p. 5494, 2012.
- [69] Q. Ren, Y. Huang, H. Ma, F. Wang, J. Gao, and J. Xu, "Conversion of glucose to 5-hydroxymethylfurfural catalyzed by metal halide in N, N-Dimethylacetamide," *BioResources*, vol. 8, no. 2, pp. 1563–1572, 2013.
- [70] X. Qi, M. Watanabe, T. M. Aida, and R. L. Smith, "Catalytical conversion of fructose and glucose into 5-hydroxymethylfurfural in hot compressed water by microwave heating," *Catal. Commun.*, vol. 9, no. 13, pp. 2244–2249, 2008.
- [71] X. Tong, M. Li, N. Yan, Y. Ma, P. J. Dyson, and Y. Li, "Defunctionalization of fructose and sucrose: Iron-catalyzed production of 5-hydroxymethylfurfural from fructose and sucrose," *Catal. Today*, vol. 175, no. 1, pp. 524–527, 2011.
- [72] K. Beckerle and J. Okuda, "Conversion of glucose and cellobiose into 5-hydroxymethylfurfural (HMF) by rare earth metal salts in N,N-dimethylacetamide (DMA)," *J. Mol. Catal. A Chem.*, vol. 356, pp. 158–164, 2012.
- [73] C. Carlini, P. Patrono, A. M. R. Galletti, and G. Sbrana Glauco, "Heterogeneous catalysts based on vanadyl phosphate for fructose dehydration to 5-hydroxymethyl-2-furaldehyde," *Appl. Catal. A Gen.*, vol. 275, no. 1–2, pp. 111–118, 2004.
- [74] F. S. Asghari and H. Yoshida, "Dehydration of fructose to 5-hydroxymethylfurfural in sub-critical water over heterogeneous zirconium phosphate catalysts," *Carbohydr. Res.*, vol. 341, no. 14, pp. 2379–2387, 2006.
- [75] V. V. Ordonsky, J. Van Der Schaaf, J. C. Schouten, and T. a. Nijhuis, "The effect of solvent addition on fructose dehydration to 5-hydroxymethylfurfural in biphasic system over zeolites," *J. Catal.*, vol. 287, pp. 68–75, 2012.
- [76] I. Jiménez-Morales, M. Moreno-Recio, J. Santamaría-González, P. Maireles-Torres, and a. Jiménez-López, "Mesoporous tantalum oxide as catalyst for dehydration of glucose to 5-hydroxymethylfurfural," *Appl. Catal. B Environ.*, vol. 154–155, pp. 190–196, 2014.

- [77] J. S. Kruger, V. Choudhary, V. Nikolakis, and D. G. Vlachos, "Elucidating the roles of zeolite H-BEA in aqueous-phase fructose dehydration and HMF rehydration," *ACS Catal.*, vol. 3, no. 6, pp. 1279–1291, 2013.
- [78] T. S. Hansen, J. Mielby, and A. Riisager, "Synergy of boric acid and added salts in the catalytic dehydration of hexoses to 5-hydroxymethylfurfural in water," *Green Chem.*, vol. 13, no. 1, p. 109, 2011.
- [79] Javier Pérez-Maqueda, Irene Arenas-Ligioiz, Ó. López, and J. G. Fernández-Bolaños, "Eco-friendly preparation of 5-hydroxymethylfurfural from sucrose using ion-exchange resins," *Chem. Eng. Sci.*, vol. 109, pp. 244–250, 2014.
- [80] R. Weingarten, G. a. Tompsett, W. C. Conner, and G. W. Huber, "Design of solid acid catalysts for aqueous-phase dehydration of carbohydrates: The role of Lewis and Brønsted acid sites," *J. Catal.*, vol. 279, no. 1, pp. 174–182, 2011.
- [81] I. Agirrezabal-Telleria, a. Larreategui, J. Requies, M. B. Güemez, and P. L. Arias, "Furfural production from xylose using sulfonic ion-exchange resins (Amberlyst) and simultaneous stripping with nitrogen," *Bioresour. Technol.*, vol. 102, no. 16, pp. 7478–7485, 2011.
- [82] P. L. Dhepe and R. Sahu, "A solid-acid-based process for the conversion of hemicellulose," *Green Chem.*, vol. 12, no. 12, p. 2153, 2010.
- [83] C. Rong, X. Ding, Y. Zhu, Y. Li, L. Wang, Y. Qu, X. Ma, and Z. Wang, "Production of furfural from xylose at atmospheric pressure by dilute sulfuric acid and inorganic salts," *Carbohydr. Res.*, vol. 350, pp. 77–80, 2012.
- [84] J. J. Blank and A. V Cefali, "HHS Public Access," vol. 3, no. 11, pp. 1268–1272, 2015.
- [85] C. García-Sancho, I. Agirrezabal-Telleria, M. B. Güemez, and P. Maireles-Torres, "Dehydration of d-xylose to furfural using different supported niobia catalysts," *Appl. Catal. B Environ.*, vol. 152–153, pp. 1–10, 2014.
- [86] K. Lamminpää, J. Ahola, and J. Tanskanen, "Bioresource Technology Acid-catalysed xylose dehydration into furfural in the presence of kraft lignin," vol. 177, pp. 94–101, 2015.
- [87] X. Shi, Y. Wu, P. Li, H. Yi, M. Yang, and G. Wang, "Catalytic conversion of xylose to furfural over the solid acid SO<sub>4</sub><sup>2-</sup>/ZrO<sub>2</sub>-Al<sub>2</sub>O<sub>3</sub>/SBA-15 catalysts," *Carbohydr. Res.*, vol. 346, no. 4, pp. 480–487, 2011.
- [88] A. S. Dias, M. Pillinger, and A. a. Valente, "Liquid phase dehydration of d-xylose in the presence of Keggin-type heteropolyacids," *Appl. Catal. A Gen.*, vol. 285, no. 1–2, pp. 126–131, 2005.
- [89] M. M. Antunes, S. Lima, A. Fernandes, M. Pillinger, M. F. Ribeiro, and A. a. Valente, "Aqueous-phase dehydration of xylose to furfural in the presence of MCM-22 and ITQ-2 solid acid catalysts," *Appl. Catal. A Gen.*, vol. 417–418, pp. 243–252, 2012.
- [90] A. S. Dias, S. Lima, M. Pillinger, and A. a. Valente, "Acidic cesium salts of 12-tungstophosphoric acid as catalysts for the dehydration of xylose into furfural," *Carbohydr. Res.*, vol. 341, no. 18, pp. 2946–2953, 2006.
- [91] R. Suxia, X. Haiyan, Z. Jinling, L. Shunqing, H. Xiaofeng, and L. Tingzhou, "Furfural

- production from rice husk using sulfuric acid and a solid acid catalyst through a two-stage process,” *Carbohydr. Res.*, vol. 359, pp. 1–6, 2012.
- [92] A. S. Dias, M. Pillinger, and A. a. Valente, “Dehydration of xylose into furfural over micro-mesoporous sulfonic acid catalysts,” *J. Catal.*, vol. 229, no. 2, pp. 414–423, 2005.
- [93] P. Bhaumik and P. L. Dhepe, “Effects of careful designing of SAPO-44 catalysts on the efficient synthesis of furfural,” *Catal. Today*, vol. 251, pp. 66–72, 2015.
- [94] H. Li, J. Ren, L. Zhong, R. Sun, and L. Liang, “Bioresource Technology Production of furfural from xylose, water-insoluble hemicelluloses and water-soluble fraction of corncob via a tin-loaded montmorillonite solid acid catalyst,” vol. 176, pp. 242–248, 2015.
- [95] W. Wang, J. Ren, H. Li, A. Deng, and R. Sun, “Direct transformation of xylan-type hemicelluloses to furfural via SnCl<sub>4</sub> catalysts in aqueous and biphasic systems,” *Bioresour. Technol.*, vol. 183, pp. 188–194, 2015.
- [96] S. Lima, M. Pillinger, and A. a. Valente, “Dehydration of d-xylose into furfural catalysed by solid acids derived from the layered zeolite Nu-6(1),” *Catal. Commun.*, vol. 9, no. 11–12, pp. 2144–2148, 2008.
- [97] W. Yang, P. Li, D. Bo, and H. Chang, “The optimization of formic acid hydrolysis of xylose in furfural production,” *Carbohydr. Res.*, vol. 357, pp. 53–61, 2012.
- [98] L. Zhang, H. Yu, P. Wang, and Y. Li, “Production of furfural from xylose, xylan and corncob in gamma-valerolactone using FeCl<sub>3</sub>·6H<sub>2</sub>O as catalyst,” *Bioresour. Technol.*, vol. 151, pp. 355–360, 2014.
- [99] I. Agirrezabal-Telleria, I. Gandarias, and P. L. Arias, “Production of furfural from pentosan-rich biomass: Analysis of process parameters during simultaneous furfural stripping,” *Bioresour. Technol.*, vol. 143, pp. 258–264, 2013.
- [100] T. Suzuki, T. Yokoi, R. Otomo, J. N. Kondo, and T. Tatsumi, “Dehydration of xylose over sulfated tin oxide catalyst: Influences of the preparation conditions on the structural properties and catalytic performance,” *Appl. Catal. A Gen.*, vol. 408, no. 1–2, pp. 117–124, 2011.
- [101] I. Sádaba, S. Lima, A. a. Valente, and M. López Granados, “Catalytic dehydration of xylose to furfural: Vanadyl pyrophosphate as source of active soluble species,” *Carbohydr. Res.*, vol. 346, no. 17, pp. 2785–2791, 2011.
- [102] I. Agirrezabal-Telleria, J. Requies, M. B. Güemez, and P. L. Arias, “Dehydration of d-xylose to furfural using selective and hydrothermally stable arenesulfonic SBA-15 catalysts,” *Appl. Catal. B Environ.*, vol. 145, pp. 34–42, 2014.
- [103] O. Yemiş and G. Mazza, “Acid-catalyzed conversion of xylose, xylan and straw into furfural by microwave-assisted reaction,” *Bioresour. Technol.*, vol. 102, no. 15, pp. 7371–7378, 2011.
- [104] L. Zhang and H. Yu, “Conversion of xylan and xylose into furfural in biorenewable deep eutectic solvent with trivalent metal chloride added,” *BioResources*, vol. 8, no. 4, pp. 6014–6025, 2013.
- [105] B. Pholjaroen, N. Li, Z. Wang, A. Wang, and T. Zhang, “Dehydration of xylose to furfural over niobium phosphate catalyst in biphasic solvent system,” *J. Energy Chem.*, vol. 22,

- no. 6, pp. 826–832, 2013.
- [106] A. S. Dias, S. Lima, M. Pillinger, and A. a. Valente, “Modified versions of sulfated zirconia as catalysts for the conversion of xylose to furfural,” *Catal. Letters*, vol. 114, no. 3–4, pp. 151–160, 2007.
- [107] V. Choudhary, A. B. Pinar, S. I. Sandler, D. G. Vlachos, and R. F. Lobo, “Xylose isomerization to xylulose and its dehydration to furfural in aqueous media,” *ACS Catal.*, vol. 1, no. 12, pp. 1724–1728, 2011.
- [108] V. Choudhary, S. I. Sandler, and D. G. Vlachos, “Conversion of xylose to furfural using Lewis and Brønsted acid catalysts in aqueous media,” *ACS Catal.*, vol. 2, no. 9, pp. 2022–2028, 2012.
- [109] W. Cortés, P. D. Departamento, D. C. Básicas, U. Jorge, and T. Lozano, “Conversion of D-Xylose Into Furfural With Aluminum and Hafnium Pillared Clays As Catalyst Conversion De D-Xilosa a Furfural Con Arcillas Pilarizadas Con Aluminio Y Hafnio Como Catalizadores,” *Dyna*, pp. 105–112, 2013.
- [110] H. Li, A. Deng, J. Ren, C. Liu, W. Wang, F. Peng, and R. Sun, “A modified biphasic system for the dehydration of d -xylose into furfural using  $\text{SO}_4^{2-} / \text{TiO}_2\text{-ZrO}_2 / \text{La}_3^+$  as a solid catalyst,” *Catal. Today*, vol. 234, pp. 251–256, 2014.
- [111] S. Lima, M. M. Antunes, A. Fernandes, M. Pillinger, M. Filipa, and A. A. Valente, “Applied Catalysis A : General Catalytic cyclodehydration of xylose to furfural in the presence of zeolite H-Beta and a micro / mesoporous Beta / TUD-1 composite material,” vol. 388, pp. 141–148, 2010.
- [112] V. V Ordonsky, J. C. Schouten, J. Van Der Schaaf, and T. A. Nijhuis, “Applied Catalysis A : General Biphasic single-reactor process for dehydration of xylose and hydrogenation of produced furfural,” vol. 451, pp. 6–13, 2013.
- [113] E. Lam, J. H. Chong, E. Majid, Y. Liu, S. Hrapovic, A. C. W. Leung, and J. H. T. Luong, “Carbocatalytic dehydration of xylose to furfural in water,” vol. 0, 2011.
- [114] M. M. Antunes, S. Lima, A. Fernandes, J. Candeias, M. Pillinger, S. M. Rocha, M. Filipa, and A. A. Valente, “Catalytic dehydration of d -xylose to 2-furfuraldehyde in the presence of Zr- ( W , Al ) mixed oxides . Tracing by-products using two-dimensional gas chromatography-time-of-flight mass spectrometry,” vol. 195, pp. 127–135, 2012.
- [115] P. a. Russo, S. Lima, V. Rebutini, M. Pillinger, M.-G. Willinger, N. Pinna, and A. a. Valente, “Microwave-assisted coating of carbon nanostructures with titanium dioxide for the catalytic dehydration of d-xylose into furfural,” *RSC Adv.*, vol. 3, no. 8, p. 2595, 2013.
- [116] I. Agirrezabal-Telleria, J. Requies, M. B. Güemez, and P. L. Arias, “Pore size tuning of functionalized SBA-15 catalysts for the selective production of furfural from xylose,” *Appl. Catal. B Environ.*, vol. 115–116, pp. 169–178, 2012.
- [117] A. S. Dias, M. Pillinger, and A. a. Valente, “Mesoporous silica-supported 12-tungstophosphoric acid catalysts for the liquid phase dehydration of d-xylose,” *Microporous Mesoporous Mater.*, vol. 94, no. 1–3, pp. 214–225, 2006.
- [118] S. Lima, A. Fernandes, M. M. Antunes, M. Pillinger, F. Ribeiro, and A. a. Valente, “Dehydration of xylose into furfural in the presence of crystalline microporous silicoaluminophosphates,” *Catal. Letters*, vol. 135, no. 1–2, pp. 41–47, 2010.



- [119] R. O'Neil, M. N. Ahmad, L. Vanoye, and F. Aiouache, "Kinetics of aqueous phase dehydration of xylose into furfural catalyzed by ZSM-5 zeolite," *Ind. Eng. Chem. Res.*, vol. 48, no. 9, pp. 4300–4306, 2009.
- [120] A.-C. Doiseau, F. Rataboul, L. Burel, and N. Essayem, "Synergy effect between solid acid catalysts and concentrated carboxylic acids solutions for efficient furfural production from xylose," *Catal. Today*, vol. 226, pp. 176–184, 2014.
- [121] M. J. C. Molina, M. L. Granados, A. Gervasini, and P. Carniti, "Exploiment of niobium oxide effective acidity for xylose dehydration to furfural," *Catal. Today*, vol. 254, pp. 90–98, 2015.
- [122] W. Wang, H. Li, J. Ren, R. Sun, J. Zheng, G. Sun, and S. Liu, "An efficient process for dehydration of xylose to furfural catalyzed by inorganic salts in water/dimethyl sulfoxide system," *Chinese J. Catal.*, vol. 35, no. 5, pp. 741–747, 2014.
- [123] Y. Román-Leshkov, M. Moliner, J. A. Labinger, and M. E. Davis, "Mechanism of glucose isomerization using a solid Lewis acid catalyst in water.," *Angew. Chem. Int. Ed. Engl.*, vol. 49, no. 47, pp. 8954–7, Nov. 2010.